

Product Catalog



**Industrial
Automation**



**Intelligent
Elevator**



**New Energy
Vehicle**

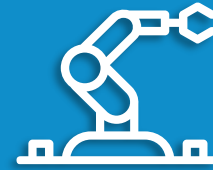

**Industrial
Robot**



Rail Transit

Industrial Automation

Industrial Automation

Sensors	AC Drives	Servo System	PLC/HMI Products	Vision Platform	Industrial IoT Products
<ul style="list-style-type: none"> ■ Absolute encoder EA35 ■ Elevator communication encoder ■ Incremental encoder EI38 series integrated elevator controller ■ Sin-cos encoder ■ Incremental encoder ■ SGD series photoelectric switch ■ SL series inductance proximity switch ■ Absolute linear optical scale 	<ul style="list-style-type: none"> ■ Low voltage AC drive MD200 MD290 MD310 MD500 MD800 MD810 MD500plus ■ Industrial AC drives MD880 DC/DC power ■ Medium-voltage AC drives HD9xs HD7xs HD3x 	<ul style="list-style-type: none"> ■ Motion controller (control card) IMC30G-E ■ Servo drives SV660 SV630 IS620 IS810 IS650P SV520 ■ Servo motors MS1-A3 MS1 series Mini MS1-T3 ISMG AP series AI series ISMT ELMI 	<ul style="list-style-type: none"> ■ Intelligent controller AC800 AP700 EP700 ■ Medium-sized PLCs AM400/AM600 ■ Small-sized PLCs H5U/H3U/H2U H1U/H3S/H2S H1S/H0U ■ I/O systems GL10/GR10 ■ HMI IT7000/IT6000 	<ul style="list-style-type: none"> ■ Kylin KINOVISION ■ FINOVISION IV700 	<ul style="list-style-type: none"> ■ IOT-WL series intelligent hardware ■ Inovance Industrial Cloud + intelligent services

AC Drives

Voltage Class

220 V, 380 V, 480 V, 690 V, 1140 V, 3 kV, 6 kV, 10 kV

Power Rating

Low-voltage AC drives: 0.2 kW to 630 kW

Industrial AC drives: 200 kW to 5.6 MW

Medium-voltage AC drives: 270 kVA to 30 MVA



Market Share of Low-Voltage AC Drives in 2020 (Industrial AC Drives Excluded)

Ranking No. 1 with a market share of 18.8%

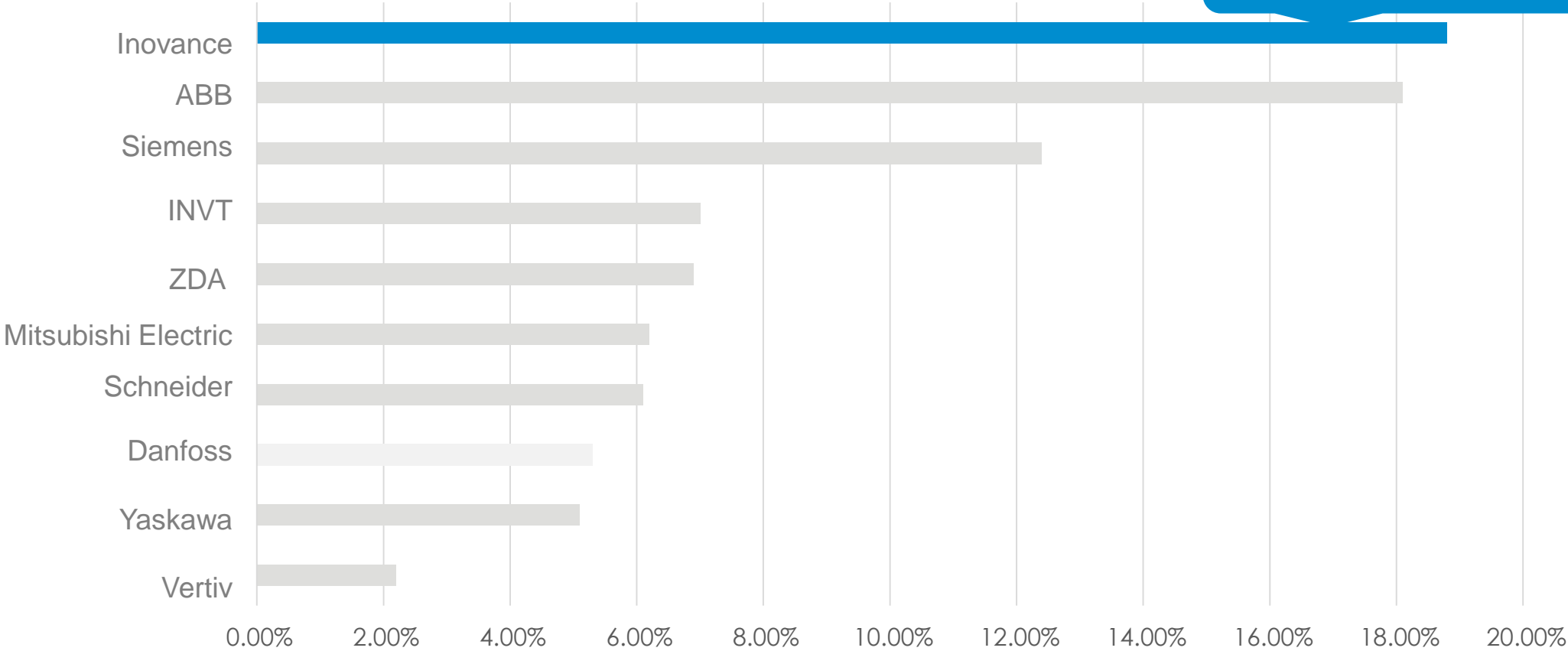

Low-Voltage AC Drive - Continuous Progress and Innovation

2003



MD320

2006



MD280

2008



MD380

2012



MD310

2014



MD500

2020



MD800

2019



MD500-PLUS

2018



MD500T13

2016







MD810

2015



MD200

Low-Voltage AC Drives

Category	Series	Target Market	Product Appearance
High performance multidrive	MD810 Power supply unit: 22–355 kW Drive unit: 1.5–355 kW	Metal cables, printing and packaging, textile printing and dyeing, chemical fiber, plastics, crane, papermaking, wind power, chemical, etc.	
High-performance vector control	MD500 Three-phase 380 V: 0.4–630 kW Three-phase 220 V: 0.4–200 kW Single-phase 220 V: 0.4–2.2 kW	Metallurgy, petrochemical, power, textile, dyeing and finishing, lifting, coiling, HVAC, glass, printing and packaging, machine tools, and air compressors, etc.	
Compact multifunction	MD310 0.4 kW to 18.5 kW Three-phase 380 VAC	Textile, papermaking, drawing, machine tools, packaging, foods, fans, and water pumps	
Voltage flux vector control	MD290 Three-phase 380V: 0.4–800 kW Three-phase 220 V: 0.4–200 kW Single-phase 220 V: 0.4–2.2 kW	Textile, boiler fan, translation mechanism, constant pressure water supply pump, plastic machinery, HVAC, petroleum, forging machine tool, and food machinery, etc.	
Mini-size	MD200 0.4–2.2 kW, single phase 220 VAC 0.4–3.7 kW, three phase 380 VAC	Woodworking, glass, food & pharmaceutical machinery, automatic production lines, and logistics equipment, etc.	

MD200 Smart AC Drive

Power: 0.4–2.2 kW, single-phase 220–240 VAC

0.4–3.7 kW, three-phase 380–480 VAC

Compact structure, powerful functions

Compared with similar products: Smaller size and higher output

Reliable and easy to use

- Over 0.8 million AC drives sold and operated stably and reliably in 6 years
- DIN rail installation available, with setting of five parameters for various applications of customers

International standards

- Meeting international standards such as UL, cUL, and CE
- EMC compliant: C2- and C3-type filters, meeting various grid requirements



Woodworking

Ceramic

Logistics

Fountain

Fan & Pump

Tissue packaging

Food

Lifting and transmission

MD290 General-Purpose AC Drive

Power: 0.4–2.2 kW, single phase 220–240 VAC

0.4–200 kW, three-phase 220–240 VAC

0.4–800 kW, three-phase 380–480 VAC

Energy-saving, easy to use, powerful functions

- Energy-saving mode for fan and water pump applications, greatly lowering the electricity fee
- Stable running ensured with functions such as flying start, power dip ride-through, and overexcitation control

Reliable and easy to use in complex environments

- Proper motor and device protection such as overvoltage, overcurrent, and short circuit protection
- Sealed structure and thickened conformal coating against pollution
- Over 0.3 million AC drives running stably in 5 years

International standards

- Meeting international standards such as UL, cUL, and CE
- EMC compliant: C2- and C3-type filters, meeting various grid requirements



Textile

Boiler fan

Translation mechanism

Constant-pressure water supply

Plastic machinery

HVAC

Forging machine tool

Food machinery

MD310 General-Purpose Compact Multi-functional AC Drive

Power: 0.4–18.5 kW, three-phase 380–440 VAC

Excellent performance

- Advanced synchronous and asynchronous vector algorithms, reducing the device size and simplifying the usage
- Power dip ride-through, overexcitation, and 180% 0.5 Hz starting torque, ensuring smooth running

Compact design, strong environmental resistance

- Over 0.6 million AC drives running stably in 8 years
- Professional environment resistant design, ensuring reliable running in environments with ceramic powder and lathe cutting fluid

Ease of use

- Default parameters meeting most application requirements
- External removable fans and parameter copy, enabling quick maintenance



Woodworking

Ceramic

Logistics

Fountain

Fan & Pump

Tissue packaging

Food

Lifting and transmission

MD500 High-Performance Vector Control AC Drive

Power: 0.4–2.2 kW, single phase 220–240 VAC

0.4–200 kW, three-phase 220–240 VAC

0.4–630 kW, three-phase 380–480 VAC

Ultra-high performance

- 150% output torque in SVC mode based on Inovance's advanced control algorithm, greatly improving the operational reliability

Compact design, strong environmental resistance

- Full 3D modeling design with size reduced by 30%, simplifying installation and maintenance
- Sealed structure and thickened conformal coating design, ensuring reliable running in environments with ceramic and metal powder, high humidity, and high temperature

International standards

- Meeting international standards such as UL, cUL, and CE
- EMC compliant: C2- and C3-type filters, meeting various grid requirements



MD800 Series AC Drive (Multidrive System)

Convergence and integration

- Bus upgrade: adapting to mainstream communication networks with cost-effective bus solutions
- Connection and commissioning within one network: CANopen/EtherCAT solution with one network
- Edge computing function: self-life management, axis abnormality diagnosis, multi-axis energy consumption statistics

Easy installation and maintenance

- 2/3 of installation space saved: equal high-depth book-size structure with more spaces for upgrade
- 2/3 of installation time saved: shortening the backplate opening time by 1/2, backplate mounting time by 1/2, and wiring time by 2/3 with pluggable terminals used, requiring no terminals
- 2/3 of commissioning time saved: multi-axis joint commissioning (1 min/axis)
- 2/3 of maintenance time saved: pluggable terminals for easy replacement without screws, modular design, and automatic parameter recovery

International quality

- International design standard: global certification standard, global mainstream power grids covered, high-level functional safety, suitable for harsh external environment, optimized EMC performance
- Support multiple application scenarios: one multi-functional machine, high starting torque, support for long cable applications, and double rated design



- | | | |
|------------------------|-------------|------------------|
| Printing and packaging | Woodworking | Food & Beverages |
| Logistics and storage | Textile | Fan & Pump |

MD810 Standard AC Drive (Multidrive System)

Power of drive unit: 1.5–355 kW (single-axis)/1.5–18.5 kW (dual-axis)

Power of power supply unit: 22–355 kW

- All buses supported: EtherCAT, PROFINET, PROFIBUS-DP, CANopen, CANlink, Modbus
- Multiple types of encoders supported: resolver, differential encoder, 23-bit encoder, sin-cos encoder, etc.
- Common DC busbar with high-efficient power distribution, improving system electric efficiency by saving 5% to 30% electricity
- Booksize module design with same height and depth available for parallel and compact installation, increasing cabinet usage and reducing the floor space; electronic integration available for onboard installation
- Self-adaptive commissioning completed in 5 minutes with connections in the same network
- Standard software integrating over 10 high-end processes such as tension control, synchronization control, and position control
- Integrated application of AC drive and servo, enabling absolute positioning with 8 million pulses per resolution

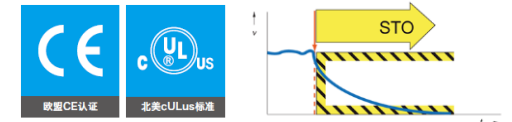

Metal cables

Printing and packaging

Textile printing and dyeing

Chemical fiber and plastic

Tower crane

Wind power

Chemical

Papermaking

High-Performance MD500-PLUS, New Product Based on the Old Platform

Improved control performance of asynchronous motor

- SVC speed regulation ratio improved to 1:1000
- Zero speed hover/tension building
- SVC used instead of FVC in applications with output torque higher than 10%
- Winding/unwinding torque accuracy in SVC $\leq 5\%$

Improved control performance of synchronous motor

- Torque accuracy in SVC: 5%
- Energy-saving algorithm for SVC
- Synchronous motor flying start, electronic shorting
- New PMVVC algorithm
- Customized models supporting high-speed application of synchronous motors at 2000 Hz

Multi-in-one

- Integrating all control algorithms (V/F, SVC, FVC, PMVVC)
- Integrating 70 customized software versions of the MD500 platform

Various high speed buses supported

- CANlink
- CANopen
- EtherCAT
- PROFINET
- Ethernet/IP



Lithium battery industry

Printing and Packaging

Vehicle equipment

Metal processing

Sewage treatment

Rubber products

MD880 AC Drive (Multidrive System)

Power: 3.7–5600 kW

- Modular hardware design and diversified power supply module types: Basic line modules, feedback line modules, and active line modules
- Hardware/Software modules matched freely, without changing parameters
- Up to 10-year hardware service life, restoring to normal within an average short time of 30 minutes with various fault rectifying mechanisms
- Well compatible with all host controllers without changing the PLC program
- Professional configuration design, application setup with software InoDriveStudio, PC, and LCD operating panel



MD880 AC Drive (Single Drive System)

Power: 3.7–500 kW; Voltage class: 400 V

Power: 560–710 kW; Voltage class: 690 V

- High power density, high junction temperature, and small size, with new-generation IGBT technology adopted
- Parallel connection of two AC drives for providing higher power
- Unified drive platform, shared software platform with multi-drive modules, and hardware modules matched freely, without changing parameters
- Professional configuration design, application setup with software InoDriveStudio, PC, and LCD operating panel



DC/DC Power

Power: 50–600 kW, 24–670 VDC
100–600 kW, 24–1000 VDC

- Performance indicators: Voltage control accuracy: 0.1% FS; dynamic response time: 5 ms (10% to 90% current) and 10 ms (-90% to +90% current)
- A maximum of 10 expansion modules allowed, meeting higher power requirements
- Hardware/Software modules matched freely, without changing parameters
- Abundant communication interfaces: Modbus TCP, CANopen, RS485, PROFIBUS-DP, PROFINET, EtherCAT, etc.



HD9xs Series – Two-quadrant Cell-cascaded Medium-voltage AC Drive

Basic features: Highly reliable cell-cascaded vector control AC drives which are based on the two-quadrant and synchronous/asynchronous motor control platform and can be built in bypass mode

Voltage range: 3–13.8 kV

Power range: 200 kVA to 30 MVA

Topology: Power cell cascaded

Applications:

Energy-saving applications in power, chemical, petrochemical, water treatment, metallurgy, municipal and other fields

Large capacity (above 10 MW) variable frequency and soft start applications

- AC drive in use reaching maximum power of 10 MW (electric water supply pump, main sintering fan)
- Maximum application altitude 4700 m, in Naqu area, Tibet
- Pioneer in applying medium-voltage 700 Hz high-speed PMSM control in China



HD9xs-R Series – Four-quadrant Cell-cascaded Medium-voltage AC Drive

Basic features: Highly reliable high-performance cell-cascaded vector control AC drives which are based on the four-quadrant and synchronous/asynchronous motor control platform and can be built in bypass mode

Voltage range: 3–13.8 kV

Power range: 200–7000 KVA

Topology: Power cell cascaded, AFE rectification

Applications: mines, cranes, test stations and other occasions requiring bidirectional energy flow between the load and the grid

- AC drive in use reaching maximum power of 14 MW (two AC drives connected in parallel)
- Batch applications of descending belt conveyors, mine hoists and high-power test benches
- Application of permanent magnetic synchronous direct drive with multi-drive belt

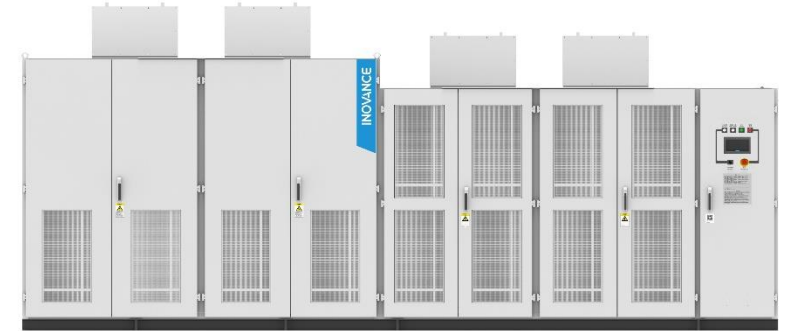

HD7xs Series – High-end Dedicated Medium-voltage AC Drive

Basic features: High-performance cell-cascaded medium-voltage AC drive targeted at segment markets such as central air conditioning, mixer, and shore power (industry-tailored or customized AC drive)

Voltage range: 3–13.8 kV

Power range: 200–15000 KVA

Topology: Power cell cascaded

Applications:

Customers and industries with special requirements

- Market share of central air conditioning ranking No.1 in China
- Market share of internal mixer drive ranking No.1 in China
- First supplier of integrated solutions for onshore power supply in China



HD3x Series – Three/Five-Level Medium-Voltage AC Drive

Basic feature: Medium-voltage AC drive based on two/four-quadrant and synchronous/asynchronous motor control water cooled platform, applying the three-level/five-level neutral point clamping topology, multi-drive common DC busbar design, and highly dynamic performance vector control algorithm

Voltage range: 2.3–3.3 kV

Power range: Three units can be paralleled for rectification and five units can be paralleled for inverter

2.5–7.5 MVA (IGBT models)

10–45 MVA (IGCT models)

Performance indicator: Torque response of 5 ms; Speed stability accuracy of 0.01% (FVC); Torque accuracy $\pm 2\%$ (synchronous motor)

Topology: Three-level/Five-level neutral point clamping topology (multi-pulse rectifier or AFE)

Application scenarios: Medium-voltage rolling mills for metallurgy

Medium-voltage high-power mine hoists

Medium-voltage high-performance test benches



Motion Control Products

Motion control card

EtherCAT control of 6 to 32 axes

Servo drive

Voltage class: 220 V/380 V, with full coverage

Power rating: 0.03 kW to 110 kW

Servo motor

Rated torque: 0.093 N·m to 10500 N·m

Rated speed: 50 RPM to 3000 RPM

Direct drive motor

Direct drive linear (DDL) motor :

Thrust range: 18 N to 900 N

Direct drive rotary (DDR) motor:

Torque: 3 N·m to 185 N·m

Serial-type magnetic scale read head



IMC30G-E Series General-Purpose Motion Controllers (Control Cards)

Bus axes: 6 axes to 32 axes

Max. number of I/Os: 768 inputs/768 outputs

High speed and high accuracy

- Accurate control of 64 slaves and 32 axes achieved in 1 ms
- Interpolation sequence error control started synchronously in 100 ns
- Look-ahead control

High synchronization with low jitter

- EtherCAT master jitter and slave clock jitter lower than ± 55 ns
- Frequency of six pulse axes up to 4 MHz, high-speed encoder input control, and high-speed position comparison output control

Comprehensive motion control

- Excellent trajectory planning curve
- Four groups of multi-axis synchronous motion available
- Electronic gear available
- High-performance motion control algorithm to satisfy multiple motion modes including PT, PVT, and interpolation (linear, circular, and helical line)

Open and easy-to-use

- Standard EtherCAT protocol compatible with various CoE slaves
- InoMotionController software tool for easy commissioning
- API function library and DEMO program



GR10 Series Distributed Expansion Modules

Digital expansion, analog, temperature detection, and high-speed counting

Excellent performance





Flexible combination

Easy operation

- No requirement for extra power supply modules due to the support for EtherCAT bus and all-in-one operation mode, simplifying system structure and maintenance
- Providing hybrid digital modules to deal with both inputs and outputs
- Providing high-speed pulse positioning and high-speed counting modules
- Supporting station numbers to be set by a rotary switch, independent of the position
- Reduced field wiring, particularly suitable for distributed applications

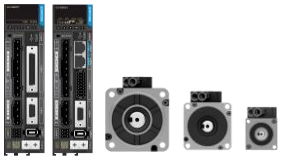

Motion Control Products – General-Purpose Servo Drive Platforms

Type	Series	Control Mode	Scope of Application	Appearance
High-performance multidrive models	IS810 850 W to 110 kW 23bit MS1-A3/ISMG motor	IS810N EtherCAT communication	Silicon, packaging and printing, forging and pressing, corrugated paper, lithium battery, molding machine, and cable	
		IS810F PROFINET communication		
		IS810P-C Pulse+CANlink communication		
		IS810P-CO CANopen communication		
All-purpose single-axis models	SV680 50 W to 7.5 kW 26-bit MS1-A6 motor	SV680N EtherCAT communication	Precision machine tool, high-speed laser, semiconductor, lithium battery, inspection equipment, pressure control, and printing	
		SV680P Pulse control		
General-purpose single-axis models	SV660 30 W to 7.5 kW 23-bit MS1-A3 motor	SV660N EtherCAT communication	Lithium battery, silicon, 3C automation, LCD, semiconductor, packaging, machine tool, laser, cable, robot, and automobile	
		SV660P Pulse control		
		SV660A CANlink communication		
		SV660C CANopen communication		
	IS620 50 W to 7.5 kW 23-bit MS1-A3 motor	IS620F PROFINET communication	Automobile, logistics, packaging, molding machine, cable, silicon, lithium battery, 3C automation, and CNC equipment	
		IS620H Mechatrolink III communication		
Economical single-axis models	SV630 50 W to 7.5 kW 18-bit MS1-T3 motor	SV630N EtherCAT communication	Manipulator, logistics equipment, textile, food packaging, woodworking, glass, LED equipment, and customization automation	
	SV630P Pulse control			
	SV630A CANlink communication			
	SV630C CANopen communication			

Market Share of General-Purpose Servo Products in China

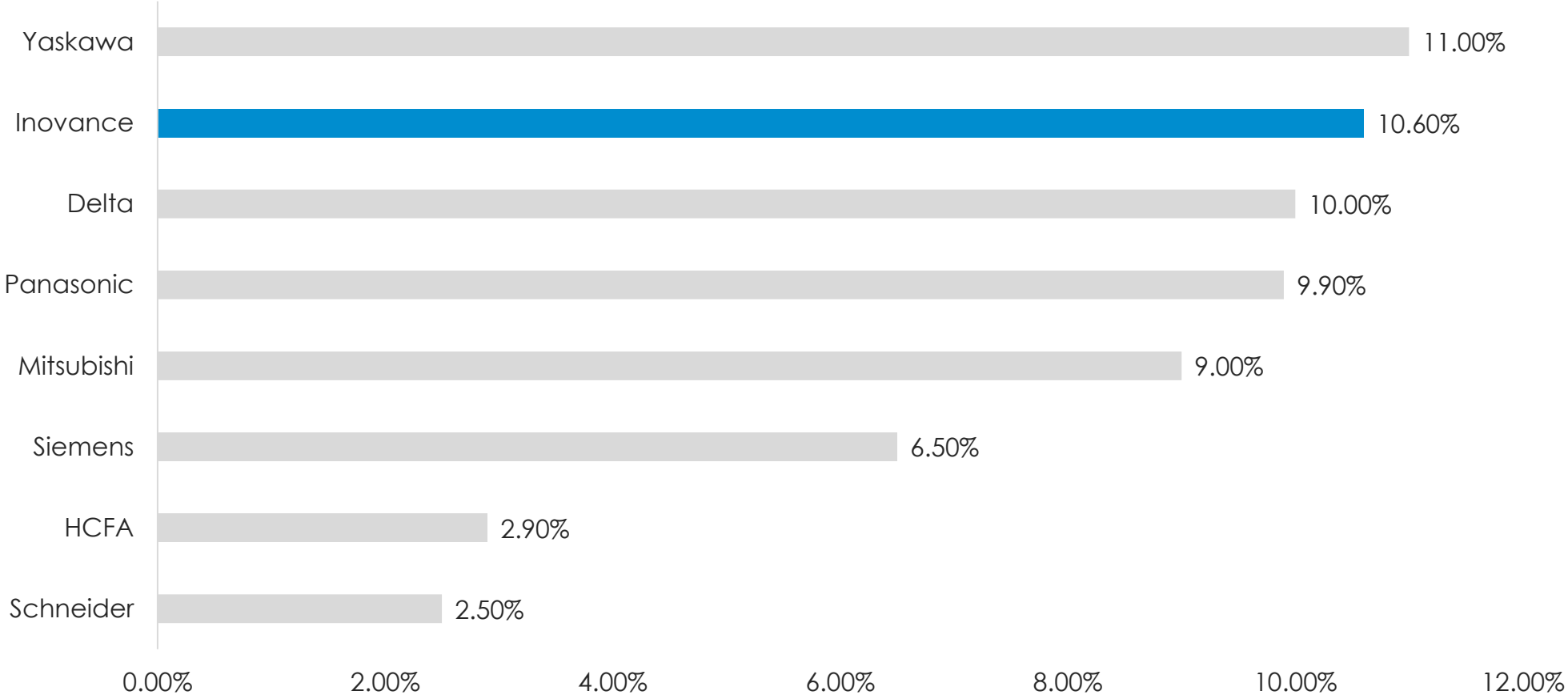

Market share of general-purpose servo products in 2020 (data source: MIR)

SV660 Series General-Purpose Single-Axis Servo Drives

Quick response

Easy-to-use

Fully certified

Safe and reliable

Power range: 30 W to 7.5 kW

Input voltage: Single-phase/Three-phase 220 VAC; Three-phase 380 VAC

- **Quick response:** Current refresh rate up to 625 kHz, speed loop bandwidth up to 3 kHz
- **Flexible control:** EtherCAT/Pulse/CAN control to fit various control needs
- **Easy commissioning:** Stiffness/Inertia/Resonance frequency auto-tuned with one key through STune; gain parameters auto-tuned through ETune
- **Compact size:** Size of 400 W models reduced by 30% to fit confined space in the electric control cabinet
- **Safe and reliable:** Dynamic brake available in all series of SV660 servo drives, and models with STO function available as option (compliant with IEC61508 SIL3)
- **Fully certified:** A full series of CE-/UL-certified and RoHS-compliant servo drives to embrace global market
- **Software tool:** Wizard-type software tool to remove the need for user guides, with multi-axis parameter access and download available in EtherCAT models



MS1-A3 Series General-Purpose Servo Motors

Rated torque: 0.3 N·m to 48 N·m Rated power: 50 W to 7.5 kW

- Equipped with 23-bit multi-turn encoder to support 16-bit multi-turn counting
- Absolute positioning accuracy lower than ± 15 arc seconds; repeatability lower than ± 3 arc seconds
- Maximum motor output torque up to 300% with torque fluctuation lower than 0.5%
- Ultra-compact size, body length of 200 W motors minimized to 72.5 mm
- Lock-type terminals to avoid shock and protection risks generated by adapters
- IP rating improved to IP67 (oil seal excluded) to ensure safe and durable operation under various working conditions
- Compliant with CE/UL certification



MS1 Series General-Purpose Mini Servo Motors

Rated torque: 0.093 N·m Rated power: 30 W

- Compact size (1/3 of a mobile phone in width) to support flange (25 mm) mounting
- Equipped with 20-bit single-turn absolute encoder developed by Inovance
- Max. motor output torque up to 350% with torque fluctuation lower than 1%
- High-speed positioning with positioning time minimized to 2 ms
- Applicable to dedicated SV660-MINI servo drives with dedicated algorithms to improve the control performance of motors with low inertia
- Targeting at semiconductors, laser cutting, and precision SMT equipment
- Supporting undervoltage protection to fulfill the needs of semiconductor test equipment



SV630 Series Economical Single-Axis Servo Drives

Cost-effective

Easy-to-use

High reliability

Power range: 50 W to 7.5 kW

Input voltage: Single-phase/Three-phase 220 VAC/Three-phase 380 VAC

- Fulfilling general positioning control and simple synchronization control demands with speed loop bandwidth up to 2 kHz
- Supporting multiple control modes (EtherCAT/Pulse/CAN) to adapt to various controllers
- Plug-in terminal block + Built-in STune/ETune function to allow easy commissioning
- Sharing the same production line with SV660 to ensure high standard of production and delivery
- Built-in dynamic brake in all series of SV630 servo drives for quick stop upon fault and exceptions
- Compliant with CE certification



MS1-T3 Series Economical Servo Motors

Rated torque: 0.3 N·m to 48 N·m Rated power: 50 W to 7.5 kW

- 18-bit multi-turn absolute encoder (1 R = 262144 pulses)
- Absolute positioning accuracy < ± 50 arc seconds, repeatability < ± 10 arc seconds
- Magnetic encoder (applicable to environments with high pollution and vibration) and photoelectric encoder (to improve accuracy) available
- Max. motor output torque up to 300% with torque fluctuation lower than 1.5 %
- IP rating of quick-locking motor connector up to IP67
- Overall IP rating of motor up to IP67 (oil seal excluded) to ensure safe and durable operation under various working conditions



IS620 Series General-Purpose Single-Axis Servo Drives

Power range: 50 W to 7.5 kW

Input voltage: Single-phase/Three-phase 220 VAC/Three-phase 380 VAC

Standardized

- PROFINET communication - Compliant with ProfiDrive motion control protocol
- Mechatrolink III communication - Applicable to mainstream CNC controllers

High performance

- 23-bit absolute encoder with a resolution of 0.15 arc seconds
- ± 20 ns synchronization jitter and 15 ns synchronization error

Easy commissioning

- Simple wiring
- Free of limit switches and home switches
- One-key tuning
- Easy battery replacement



IS810 Series High-Performance Multi-Axis Servo Drives

Power: 850 W to 120 kW

Industrial-style design

- Gray color
- Neat and compact
- Simplified outline

Easy-to-use

- Pluggable terminals with minimal connectors
- Power-on DC soft charge unit, maintenance even at power-on
- Wiring and commissioning time minimized to 15 minutes
- Simple wiring
- Free of limit switches and home switches
- One-key tuning
- Easy battery replacement

High performance

- 625 K current loop refresh cycle, 3 K speed loop bandwidth
- CE- and STO-certified, with STO compliant with SIL3 (IS810N)
- Printing deviation in flexo printing machine lower than 0.1 mm
- Frequency division output function meeting the following requirements in gravure printing machine:
 - 1) deviation at acceleration/ deceleration lower than 0.01 mm
 - 2) deviation at constant speed equal to 0.005 mm



ISMG Series High-Power Servo Motors

Torque: 50 N·m to 510 N·m

Speed: 1500 RPM, 1700 RPM, 2000 RPM

Quick positioning

Vibration/Shock resistance

Optional cooling mode

- Power ranging from 7.5 kW to 110 kW, with 23-bit absolute encoder as standard
- IP54 design and vibration/shock-resistant encoder structure to fit most of the industrial applications
- Unique electromagnetic design and air-cooling circuit with built-in thermal protector to eliminate the risk of demagnetization within the product life cycle
- Optional brake with braking torque up to 150 N·m available for ISMG1 series motors



IS650P Series Medium- to High-Power Servo Drives

Power: 7.5 kW to 60 kW

High performance

- 20-bit encoder, speed loop bandwidth up to 1 kHz, and no-load stiffness level up to 23

High resolution

- Much higher than 10,000 PPR of 2500-PPR encoder

Superior vibration resistance

- Flexible connection applied in the encoder structure, with vibration resistance capacity up to 5 G

Cost-effective

- Air cooling motor, which is more cost-effective than naturally ventilated motor of the same power

Safety

- PTC protection and high IP rating (IP67) to prevent motor damage and intrusion of unwanted object into the encoder



SV520 Series Linear Motor Servo Drives

Power: 200 W to 750 W

Flexible application

Easy commissioning

Safe and stable operation

- 16 kHz current loop control to reduce motor noise
- Multiple kinds of encoders applicable to pulse/communication-type grating and magnetic grating
- Applicable to linear motors in flat plate type, U type, barrel type, and voice coil type
- Supporting multiple control modes - Pulse, CAN, and EtherCAT
- Wizard-style software tool for easy control of motor operation
- Dedicated angle auto-tuning solution to fit various application scenarios
- Built-in dynamic brake for quick stop upon faults



AP Series Flat-Type Precision DDL Motor with Iron Core

Continuous thrust: 68 N to 460 N

Quick response

- Direct drive, high stiffness, and quick response
- 3 G to 5 G acceleration available for large linear motors

High accuracy

- Direct drive to remove the transmission part and backlash
- Fully-closed loop position control with high precision and repeatability up to 1 μm

Wide application

- Independent operation of multiple rotors available in one axis
- Unlimited travel distance available in theory through splicing stators

High speed

- Max. speed up to 5 m/s normally

Easy maintenance

- Contactless transmission featuring simple structure and low maintenance cost owing to zero friction

High thrust density and low cogging force

- Unique electromagnetic solution with low cogging force and stable thrust
- Silicon sheet integrated into the rotor to allow high thrust density

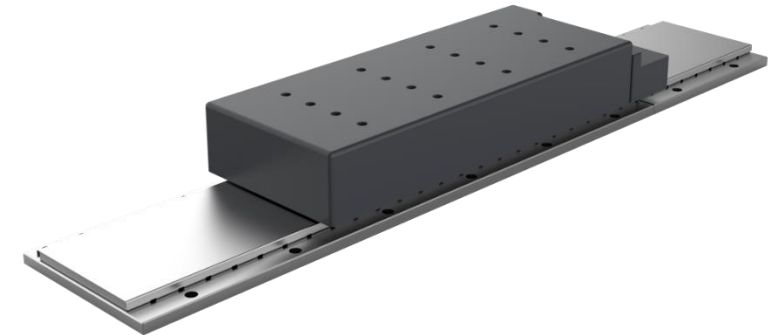

AI Series U-Type Precision DDL Motor Without Iron Core

Continuous thrust: 18 N to 900 N

Quick response

- Direct drive, high stiffness, and quick response
- Acceleration above 5 G available for large linear motors

High accuracy

- Direct drive to remove the transmission part and backlash
- Fully-closed loop position control with high precision and repeatability up to 1 μm

Wide application

- Independent operation of multiple rotors available in one axis
- Unlimited travel distance available in theory through splicing stators

High speed

- Max. speed reaching 5 m/s to 10 m/s normally

Easy maintenance

- Contactless transmission featuring simple structure and low maintenance cost owing to zero friction

Ultra-high speed stability

- No cogging force and high speed stability

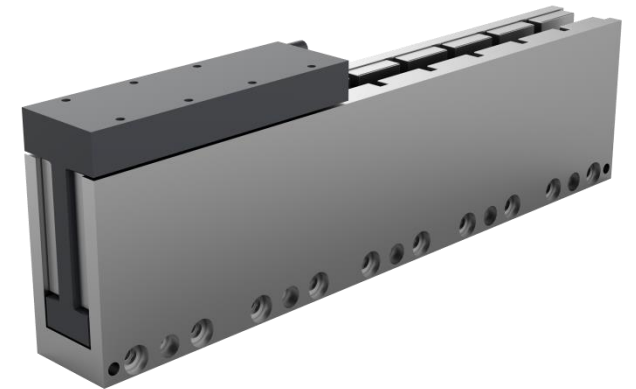

ISMT Series Precision DDR Motors

Continuous torque: 3 N·m to 185 N·m

Quick response

- Direct drive, low load inertia, high stiffness, quick response
- Synchronization of 100 axes within 1 ms
- 1.2 kHz speed loop bandwidth

Accurate positioning

- Direct drive without backlash
- High positioning accuracy and repeatability available through closed-loop position feedback and crossed roller bearing featuring high precision and high stiffness

High accuracy

- Axial/Radial load runout on the load connection side up to 5 μm
- Direct drive without backlash or clearance to allow low load runout

Easy to use

- Simple wiring
- Commissioning and analysis performed directly through the software tool
- One-key commissioning
- Fully-enclosed crossed roller bearing used as support, removing the need for maintenance

High load-carrying capacity

- High stiffness to allow high stability with accuracy kept stable in long-term operation
- Crossed roller bearing used as support to allow high load-carrying capacity and high stiffness

Flexible

- Various motion angles available to allow flexible design
- Hollow design to hold cables, air pipes, and shafts, facilitating design and application



ELMI Series Magnetic Encoders

Resolution: 1 μ m

Easy installation

- Built-in LED to allow users to install the magnetic encoder easily

Wide speed range

- Resolution of 1 μ m available with speed up to above 5 m/s

Strong environment adaptability

- Applicable to harsh environments with operating temperature ranging from -20°C to +50°C owing to an IP rating up to IP67 and fully-enclosed design

High accuracy

- High accuracy and repeatability up to $\pm 2 \mu$ m/m

High interference resistance

- High interference resistance capacity owing to Inovance serial communication protocol and RS485 output

Wide application

- Widely applied to motion systems including automation and assembly systems, metal cutting, stone cutting, sawing, textile, plastic processing, woodworking, packaging, and electronic chip/circuit board production

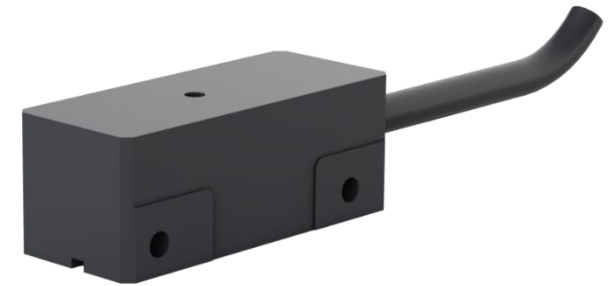

High Precision Platforms for Precision Customization

Continuous thrust: 18 N to 900 N

Abundant platforms

- Various types of platforms available as needed, including dual-drive gantry, single-drive gantry, cross module, and fixed crossbeam gantry

High accuracy

- High positioning accuracy and repeatability available through closed-loop position feedback with high-precision grating

High integration

- Compatible with Inovance PLCs, control boards, and drives to achieve system integration

Easy-to-use

- Inovance linear motor + SV520 series servo drives featuring high usability and cost effectiveness

Wide application

- Customizable based on process needs to fit different applications including dispensing, inspection, alignment, and fitting

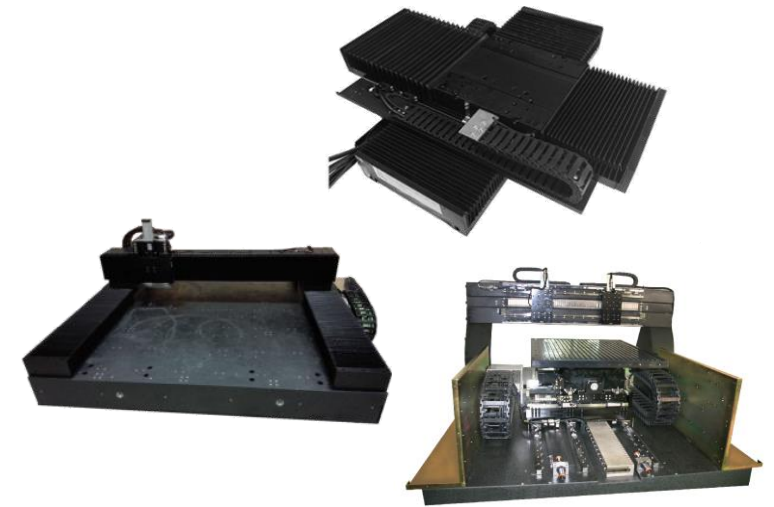

Sensor Products - Absolute Encoders

EA35 multi-turn absolute encoder

- $\Phi 35$ outer diameter, $\Phi 6$ or $\Phi 8$ hollow shaft
- 26-bit + 12-bit resolution, with absolute positioning accuracy of 15 arc seconds
- Unique compensation circuit against aging light source to improve encoder reliability
- Applicable to multiple kinds of automation equipment
- External battery for the convenience of maintenance



Elevator communication-type encoder

- $\Phi 53$ outer diameter and hollow shaft, compatible with sine/cosine encoder structure and mounting mode
- Absolute encoder with 23-bit resolution
- Storage of tuning angle, traction machine parameters, and other accessible parameters available to remove the need for field tuning
- Easy check on encoder fault owing to auto-inspection warning
- Binding with aftermarket service through protocol



Sensor Products - Incremental Encoders

EI38 series incremental encoder

- $\Phi 38$ outer diameter, $\Phi 6$ or $\Phi 8$ shaft diameter, $\Phi 6$ or $\Phi 8$ hole diameter
- Unique compensation circuit against aging light source to improve encoder reliability
- Applicable to multiple kinds of automation equipment
- Outlet from the cable side, small size, light weight, and easy installation



Sine/Cosine encoder

- $\Phi 53$ outer diameter, conical hollow shaft, and bulge loop structure
- Unique compensation circuit against aging light source to improve encoder reliability
- Closed-loop speed control of synchronous motors and elevator traction machines
- Outlet from the rectangle socket, small size, light weight, and easy installation



Sensor Products - Incremental Encoders

SGD series photoelectric switch

- Applicable to elevator leveling control, industrial automation control systems, and automatic production lines
- Can be connected to a PLC or used to drive a relay
- Waterproof, vibration resistance, and high reliability
- Annual volume over 600,000 pcs and various types of switches available, such as the through-beam type, diffuse-reflective type, and retro-reflective type



SL series inductance proximity switch

- Applicable to position control and speed control in industrial automation control systems, automatic production lines, automation-tailored machines, and CNC machine tools
- Can be connected to a PLC or used to drive a relay
- Waterproof, oil resistance, vibration resistance, and high reliability



Linear absolute optical scale

- Absolute position measurement within the full range, removing the need for auto-tuning after long-term power-off
- Linear measurement length up to 392 m with a resolution of 1 mm, measurement speed up to 8 m/s (or higher as customized)
- Incremental track and absolute track to deliver a safe and reliable real-time checking system
- Optical redundancy design to resist optical system pollution
- Applicable to automation equipment such as elevators, cranes, and automated warehouses



PLC/HMI Products



PLC/HMI Products

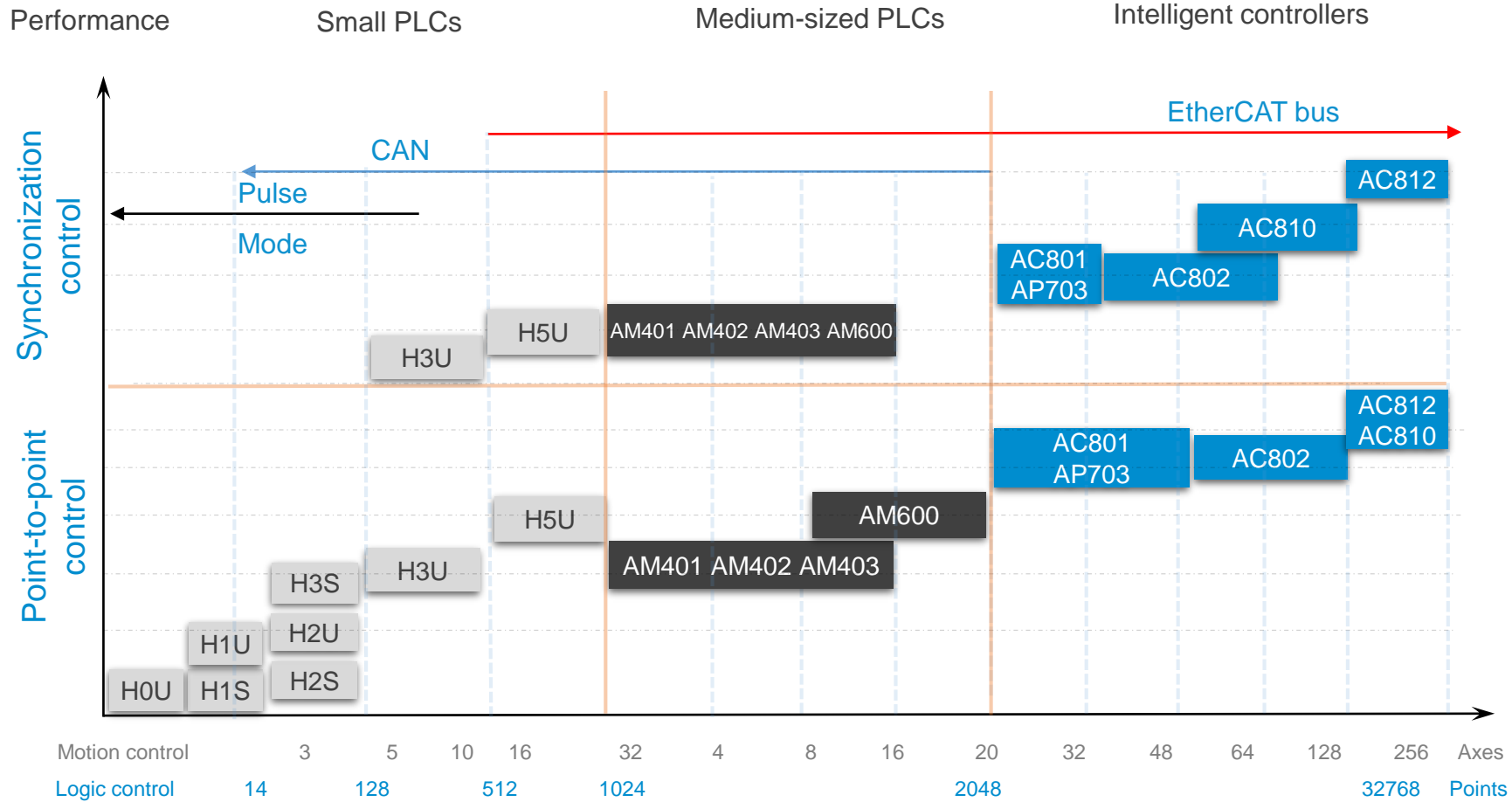

Intelligent Controllers - AC800 Series High-Performance Intelligent Controller

- Performance: AC812, which is especially applicable to synchronization control with high speed and high precision, adopts IntelCore-i7+DDR+SSD (IntelCeleron for AC801 and AC802; i5+DDR+SSD for AC810) and carries an industry-leading computation speed, with 8 axes computed in 250 us, 32 axes in 500 us, and 256 axes in 4 ms.
- Axis-carrying capacity: Powerful multi-axis motion control, with 256 axes for AC810 and AC812, 128 axes for AC802, and 48 axes for AC801
- Function: Supporting the manipulator, CNC, electronic cam, and electronic gear
- High accuracy: Jitter ≤ 30 us
- Data processing library: Processing big data and files as well as collecting and processing data of production lines
- Abundant data exchange channel and all-in-one network: OPC UA+EtherNet/IP industry buses
- Communication capacity: Two EtherCAT interfaces, two Ethernet interfaces, four USB interfaces, one RS485 interface, one RS232 interface, and external communication extension available
- Integrated with industry process libraries such as packaging, lithium battery, silicon, and mobile phone industries



EtherCAT
Conformance tested

Intelligent Controllers - AP700 Series Intelligent Controller Integrated with Display and Control for Flexible Process

- EtherCAT bus with up to 48 axes expandable, especially suitable for the control of generic machine tools
- Integrated with display and control together with built-in PLC, HMI, cam control and CNC function to allow efficient and smooth internal data exchange
- Dual-channel, multi-channel and multi-station synchronous interpolation
- Open programming interface to allow customized software control development
- Supporting auxiliary axis control (electronic cam, electronic gear and PTP control)
- Integrated with manipulator control model and automatic loading/unloading function
- Map function to allow users to read DXF and DWG files for visualized trajectory monitoring
- Configuration modules to allow easy modification and adaptation to customized requirements
- Teach function
- Unlimited expansion of I/Os and analog modules
- Customized external operating panel and customized software



EtherCAT[®]
Conformance tested

Intelligent Controllers - EP700 Series Intelligent Controller Integrated with Display and Control for Flexible Process

- Adopting IEC61131-3-compliant development tool CODESYS for powerful secondary development
- Supporting multiple communication protocols and expansion of third-party application functions
- Professional application library for plastic industry and modular encapsulation for flexible calling
- Graphical programming to allow settings of the core, servo rotary platen, hydraulic valve block, and servo pump
- Real-time process oscilloscope display and quick import of mold parameters to ensure stable and efficient production

EP700E

All-electric
injection molding machine

EP700B

Bending machine



EtherCAT®
Conformance tested

Medium PLCs - AM400/AM600 Series General-Purpose PLC

- EtherCAT axis control: 20 axes recommended for AM600, 16 axes for AM403, 8 axes for AM402, and 4 axes for AM401; two axes can be controlled synchronously within 1 ms, applicable to control of medium-sized equipment
- 10 M program capacity and 20 M data capacity
- Supporting PLCopen motion control instructions (electronic cam, electronic gear, and interpolation) and coordinate transform instructions
- Ethernet or USB-based monitoring and commissioning, compliant with IEC61131-3
- 16 high-speed inputs and 4 pulse outputs available in the host
- Abundant bus networks: Supporting EtherCAT, CANopen, CANlink, Ethernet: ModbusTCP master-slave protocol, FreeTCP, and two RS485 interfaces: ModbusRTU master-slave protocol



EtherCAT
Conformance tested

Small PLCs - H5U Series High-Performance PLC with EtherCAT Bus

- Supporting 32-axis EtherCAT bus motion control, PTP control, torque control, cam, and interpolation
- Supporting function block encapsulation, import/export of libraries, offline simulation, and online modification
- Supporting servo commissioning through PLC software tool and tagged communication with IT7000 touchscreen
- Supporting 72 EtherCAT slaves
- Supporting up to 16 GL series local expansion modules in the host
- Adopting LD/SFC programming and supporting FB/FC function (LD) and function block authorization
- Supporting 4-axis 200 kHz pulse output and four 200 kHz high-speed inputs in the host
- Supporting ModbusTCP and Socket instructions through CAN and RS485 communication
- Supporting customized graphic block instructions



Small PLCs - H3U Series High-Performance PLC with CAN Bus

- Supporting eight 200 k high-speed pulse inputs
- Supporting five 200 k high-speed pulse outputs with abundant positioning instructions and S-curve acceleration/deceleration
- Supporting 2-axis circular interpolation and linear interpolation in high-speed output
- Providing independent serial communication ports COM0 and COM1 and supporting USB monitoring and download
- Providing Ethernet interface in the master module and supporting Modbus-TCP
- Providing CAN communication interface in the master module and supporting CANopen and CANlink protocols
- Carrying 64k-step program flash storage that requires no battery
- Carrying the power failure retentive register with 32k-word R element and 8k-word D element, requiring no battery
- Improving overall scanning speed by 150% compared with H2U-XP
- Supporting up to eight GL10 expansion modules
- Supporting eight external interrupt inputs
- Adding more than 120 new instructions including floating point operation, data block processing, matrix processing, character string processing, and positioning instructions



CANlink

CANopen

Small PLCs - H2U Series General-Purpose PLC

- Providing multi-channel, high-frequency, and high-speed I/O interfaces and abundant motion and positioning control functions
- Providing three independent serial communication ports (COM0, COM1, and COM2); supporting USB monitoring and download and CANlink 3.0 networking
- Providing abundant communication protocols and communication instructions for convenient system integration
- Supporting encryption of user program download/upload and subprograms to protect the intellectual property of users
- Carrying 16k-step program flash storage that requires no external expansion memory card
- Featuring fast computation and supporting up to 127 subprograms, 4 encrypted subprograms, and 21 interrupt subprograms; supporting user programs and all power failure retentive elements to be saved permanently upon power failure
- Built-in power supply with high capacity to power up the sensor, HMI, and external intermediate relay

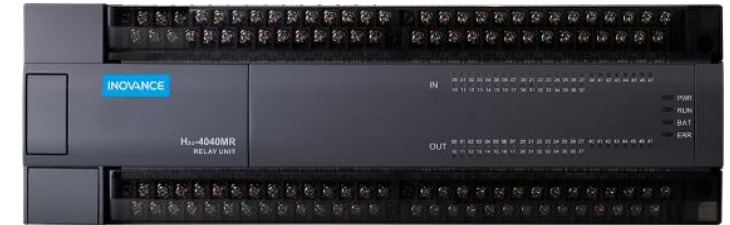

CANlink

Small PLCs - H1U Series Simplified PLC

- Providing multi-channel, high-frequency, and high-speed I/O interfaces and abundant motion and positioning control functions
- Providing two independent serial communication ports and abundant communication protocols; supporting USB monitoring and download
- Carrying powerful networking capacity and supporting CANlink 3.0 networking; providing Modbus instructions for the convenience of system integration
- Providing communication configuration functions available only in medium-sized PLCs
- Providing comprehensive encryption functions to protect the intellectual property of users
- Carrying 16k-step program flash storage that requires no external expansion memory card
- Supporting user programs and all power failure retentive elements to be saved permanently upon power failure
- Supporting real-time clock to operate for at least a week without battery upon power failure



CANlink

Small PLCs - H3S Series High-Performance Economical PLC

- Supporting 64K-step program storage space and 48K-word data storage capacity
- Carrying two serial ports to support Modbus and monitoring protocols
- Carrying one 100M Ethernet interface to support Modbus TCP/IP and free port protocols
- Supporting five 200 kHz pulse outputs and abundant positioning control instructions to achieve S-curve acceleration and deceleration, cam synchronization control, and 2-axis linear interpolation and circular interpolation
- Supporting four 200 kHz high-speed inputs for single-phase/AB-phase pulse counting; supporting interrupt and pulse capture
- Supporting USB interface or Ethernet interface to be used as the programming interface



Small PLCs - H2S Series General-Purpose Economical Small PLC

- 8K-step program storage space
- One RS485 and one RS485/RS422 communication ports which support HMI Modbus communication
- Three 100 kHz pulse outputs with various positioning control commands
- Two 60 kHz and four 10 kHz high-speed inputs, single-phase and AB phase pulse counting, and interrupt and pulse capture
- Support up to 256 I/O points and 4 special expansion modules
- Program downloading and commissioning through a USB port



Small PLCs - H1S Series Simplified Economical Small PLC

- 8K-step program storage space
- One RS485 and one RS485/RS422 communication ports which support HMI Modbus communication
- Program downloading and commissioning through a USB port
- Multi-channel high-speed I/O ports with abundant positioning control functions



Small PLCs - H0U Series Integrated Multifunctional Small PLC

- Integration of PLC and text
- 6 high-speed inputs and 2 high-speed pulse outputs (only for the transistor output type)
- 2 serial RS485 communication ports and 1 USB port
- 25 customizable function keys
- PLC program downloading through AutoShop and TOD program downloading through HTodEditor



I/O Systems - GL10 Series Centralized Expansion Module

- H3U, H5U, AM400, and AM600 local expansion supported
- Support for EtherCAT bus expansion The expansion bus can be connected to the EtherCAT bus through a protocol conversion coupler, which enables a free combination of function modules to form a modular I/O system.
- Equipped with power supply module to provide excellent anti-interference performance
- Free combination of functional modules to form a modular I/O system to meet different requirements
- Expansion modules including digital, analog, and temperature detection modules
- Suitable for centralized applications involving a large number of points (256 points or 16 function modules)



Category	Designation	Module Name
GL10 series power supply module	GL10-PS2	GL10 series power supply module
GL10 series coupler module	GL10-RTU-ECTA	GL10 series EtherCAT gateway module (supporting auto scan)
	GL10-RTU-COP	CANopen slave module, allowing expansion of 16 I/O modules
GL10 series expansion module	GL10-1600END	GL10 series 16-in expansion module
	GL10-0016ETP	GL10 series 16-transistor output (PNP) expansion module
	GL10-0016ETN	GL10 series 16-transistor output (NPN) expansion module
	GL10-0016ER	GL10 series 16-RO expansion module
	GL10-3200END	GL10 series 32-in expansion module
	GL10-0032ETN	GL10 series 32-transistor output (NPN) expansion module
	GL10-4AD	GL10 series 4-voltage/current input expansion module
	GL10-4DA	GL10 series 4-voltage/current output expansion module
	GL10-8TC	GL10 series 8-thermocouple input expansion module
	GL10-4TC	GL10 series 4-thermocouple input expansion module
	GL10-4PT	GL10 series 4-RTD input expansion module
	GL10-4PM	GL10 series 4-200 kHz HS DIFF pulse output expansion module (for H3U)
	GL10-2PH	GL10 series 2-1 MHz HS DIFF pulse output expansion module (for H3U)

I/O Systems - GR10 Series Distributed Expansion Module

- Support for EtherCAT bus allows for compatibility with third-party EtherCAT masters, not requiring additional power supply module
- Hybrid digital modules available to deal with both input and output
- High-speed pulse positioning and high-speed counting modules available
- Station number set by a rotary switch, independent of the position
- Reduced cable connection, particularly suitable for distributed applications



Category	Designation	Module Name
GR10 series expansion module	GR10-0808ETNE	GR10 series 8-in/8-transistor output EtherCAT remote independent module
	GR10-1616ETNE	GR10 series 16-in/16-transistor output EtherCAT remote independent module
	GR10-2HCE	GR10 series 2-HS count EtherCAT remote independent module
	GR10-4PME	GR10 series 4-pulse positioning output EtherCAT remote independent module
	GR10-4ADE	GR10 series 4-voltage/current input EtherCAT remote independent module
	GR10-4DAE	GR10 series 4-voltage/current output EtherCAT remote independent module
	GR10-8TCE	GR10 series 8-thermocouple input EtherCAT remote independent module
	GR10-8PBE	GR10 series 8-probe EtherCAT remote independent module
	GR10-2PHE	GR10 series programmable controller 2-HS DIFF pulse output EtherCAT slave remote expansion module
	GR10-EC-6SW	GR10-EC-6SW-GR series 6-EtherCAT branch module
	GR10-4TCS-PID	GR10 series 4-thermocouple input temperature controller
	GR10-4PTS-PID	GR10 series 4-RTD input temperature controller

HMI's - IT7000 Series Fully Configurable Open HMI

Sizes: 7", 10", and 15"

- Appearance and experience with a sense of high-tech: metal enclosure with excellent texture and durability; highly-flat and high-protection glass panel; thin and light body saves the installation controls; high-speed processor meets the users' requirement for high-quality operating experience; high display-to-body ratio: 4:3 (industry mainstream: 16:9)
- Highly configurable software platform: free configuration of graph, text, and data objects to achieve various functions; support for the text input and display of all standard languages; expandable software platform allows the import of user-defined controls; free drawing through a canvas control; script programs available to access local and remote databases; import of most vector graphs and images; mirroring of running screens to mobile devices (mobile phones, Pads)
- Multi-dimensional networking solutions: solution for the communication connection between Inovance HMI and the PLC of mainstream brands; interconnection of Ethernet and WIFI networking with the field, remote, and mobile devices; OPC UA access to information system



HMI's - IT6000 Series General-Purpose HMI

Sizes: 4.3", 7", and 10"

- Improved speed and experience
- Dramatically quicker page switching
- The 7" HMI comes with 16-bit color and 800 x 480 resolution.
- The 10" HMI comes with 24-bit color and 1024 x 768 resolution
- Easy-to-use data/historic table controls
- Support for S7-300MPI protocol
- Video input (coming soon)
- Easier host controller configuration software



Vision Platform Product — KINOVISION

- Integration: The KINOVISION-Light, KINOVISION-Master, and KINOVISION-Super series provide complete software and hardware integration solutions for industrial vision applications.
- Various recipes: Different models and options are available for different scenarios.
- Typical technology package: The process package with quick startup and typical process configuration is provided.
- Customized design: The customized optical system solution for special applications is supported.
- High integration of tools: Developed by users themselves based on the platform without requiring encoding, the efficient and stable algorithm tool as well as flexible and easy-to-use system control tool meet various industrial vision requirements.
- Neat and individualized JOB user interface: Customers can personalize the logic interaction interface.
- Applications: household appliances, 3C, lithium battery, robots, food, pharmaceuticals, and other production lines



Self-Annotation Training Product — FINOVISION IV700

- Integration of data annotation, data management, model training, model testing, and precision analysis, providing a deep learning-based solution for industrial vision inspection
- Integrates image classification, target detection, character recognition, and image segmentation to achieve highly precise and efficient model training through annotation, training, pre-inspection, and tuning
- Simple and flexible user interface, wizard-style configuration
- Flexible and efficient model inference
- Support for multiple hardware platforms
- Scientific and intelligent precision analysis
- Applications: household appliances, 3C, lithium battery, robots, food, pharmaceuticals, and other production lines



Industrial IoT Products

Currently, over 420,000 devices are connected to Inovance's industrial IoT cloud platform. We are now providing IoT services for customers in the industries of elevators, air compressors, logistics vehicles, bus air conditioners, cranes, and textile.

With in-depth integration of industrial automation and information technology as the core, Inovance offers end-to-end solutions covering the sensing layer, transmission layer, support layer, and application layer to implement Internet plus devices and Internet plus factories, improving the industrial efficiency and promoting traditional industry upgrading.

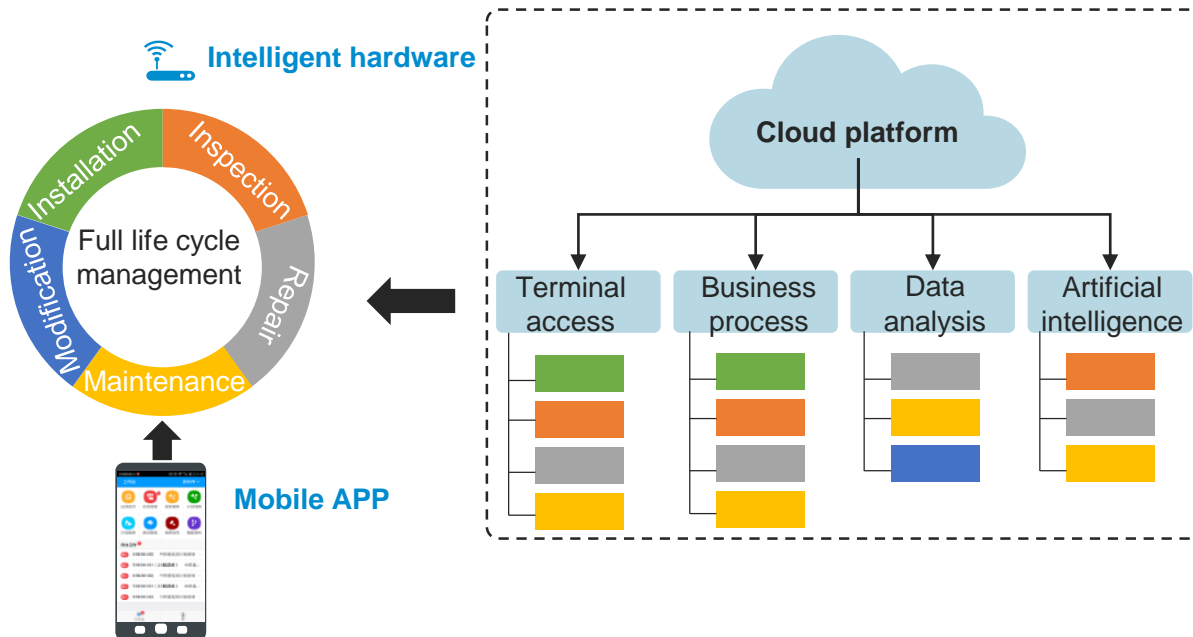

Service expansion of three categories of products on five life nodes in the after service market is implemented through four types of technologies.



Industry-Tailored Products



Integrated elevator controller/control cabinet



Integrated crane drive



Hydraulic servo products



Textile drive



Machine tool products



Integrated AC drive for air compressors



New energy vehicle air conditioning drive



Wind power variable-pitch drive



Integrated drive for water pumps



Ceramic-dedicated motor integrating drive and control

Integrated Elevator Controller/Control Cabinet

Integrated elevator controller

The NICE series integrated elevator controllers integrate the elevator logic control and traction machine drive, simplifying the elevator control and drive system, reducing the cost, and improving the reliability. They can control and drive passenger elevators, freight elevators, villa elevators, escalators, and peripheral devices such as the door operator.

- NICE3000new series

Integrated elevator control cabinet

- Conventional elevators: NICE3000B cabinet, Tomorrow cabinet
- Home elevators: Honor cabinet, Jiaolong cabinet



AC Drive for Cranes

The CS series crane-dedicated AC drives target at special needs of various lifting loads, such as the construction hoist, tower crane, gantry crane, electric hoist, and portal crane. This series features excellent performance, integrates various crane software, and supports the expansion of multiple crane process cards, meeting the control and drive requirements of cranes.

- CS290 high-performance V/f crane AC drive
- CS300 low-power mini crane AC drive
- CS710 high-performance crane AC drive
- MD810-CS crane AC drive (multidrive system)
- MD880-CS industrial crane AC drive

Inovance drafts the industry standards of crane AC drives and construction hoist AC drives.



Injection Molding Machine-dedicated Products

Working with the ESMG series servo motor, the IS580 series servo drive is used for the control and drive of injection molding machines. It features low noise, high efficiency, and remarkable energy saving.

The ES810, which is used with the high-performance, high-response and low-inertia ESMQ series injection motor, is a servo drive specialized for all-electric injection molding machines. It can output large instantaneous overload torque, meeting the all-electric injection process and rapid mold opening/closing requirements. With a control period of 200 μ s, the ES810 guarantees the high-precision control of injection molding machines.

Other products:

- ESMG series servo motor
- EP700E series injection molding machine controller
- ESMQ series high-response servo motor
- Electric melting servo drive cabinet



Integrated Servo Drive — ES580C Servo Drive Cabinet

Power: 160–400 kW

High IP rating

CE certification

**Convenient
commissioning**

- High-quality delivery: enables on-time delivery in an easy way
 - High IP rating: IP54 and IP43 available
 - Excellent EMC: CE-certified multi-dimensional EMC scheme
 - Large heat dissipation area: high reliability and environmental worthiness
 - Convenient installation: user-friendly design and built-in braking components
 - All-round safety protection design
- The ES580C, a new-generation integrated servo drive cabinet developed for driving the permanent magnet synchronous motor (PMSM), can realize the high-performance vector control of PMSM. By integrating various electrical peripherals, it facilitates the integrated delivery and application on clients.
- Using the high-performance vector control technology, the ES580C features high torque output at a low speed, excellent dynamic characteristics, and superior overload capability. It provides the user programming, software monitoring, and communication bus functions and supports multiple encoder types, realizing flexible function combinations and stable performance.



High-Power Servo Motor — MEG Series Servo Motor

Torque: 50–1500 N·m

Rotational speed: 1200–2000 rpm

Large torque

Low temperature rise

IPM

- All-electric motor developed based on the IPM motor platform, with all advantages of IPM motor (small current, low temperature rise, excellent anti-demagnetization capacity, etc.)
- Works with a 23-bit multi-turn cross-joint absolute encoder to realize high rotary accuracy.
- Lower current and temperature rise under same torque
- **Applicable industries: electric melting, aluminum profile extrusion, and die casting machine**



Textile Drive

Based on the requirements of customers in the textile industry, Inovance develops various textile-dedicated drives, including the spinning frame spindle AC drive, two-for-one twister transverse servo drive, electronic let-off and take-up servo drive, ITD500 super-start AC drive, and water/air jet loom electronic control system. These products are widely used in various textile machinery and meet the strict performance and reliability requirements of the textile industry.

- Spinning frame spindle AC drive
- Spinning frame molding servo drive
- Two-for-one twister transverse servo drive
- Double winder two-in-one servo drive
- ITD500 super-start AC drive
- Cotton fiber-proof AC drive
- Electronic let-off and take-up servo system



Machine Tool Drive — CT620 Closed Loop Positioning AC Drive

Power: 3.7–11 kW, three-phase 380 VAC

- Easy-to-use functions, with the same form, overload capacity, and interfaces as the servo drive
- High resolution at low-speed positioning and excellent speed stability at high speed
- Supports the pulse, sin/cos, and communication encoder inputs, applicable to the closed loop positioning of spindle motor, tapping, and other controls
- Three control modes available: high-speed pulse, RS485, and analog
- High IP rating and independent air duct, suitable for machine tool application environments requiring strict protection
- CE certification



Low-voltage AC drive

Applicable industries

Machine tool	High-precision engraving machine	Glass making machine	Lathe	Turning and milling machine	Engraving and milling machine	Drilling and tapping center	Machining center	Grinder
--------------	----------------------------------	----------------------	-------	-----------------------------	-------------------------------	-----------------------------	------------------	---------

CNC — MTC600 Series General-Purpose Milling Machine CNC System

30 years of self-developed core high-end algorithm accumulation (originates from Germany)

- Supports gantry/parallel/non-quadrature axis control and polar/cylindrical coordinate transformation
- Supports space cutter compensation, linear/circular/helical/spline interpolation, and corner smoothing/accuracy control
- Supports the curvature function, adaptive look-ahead for 4,000 segments, and five-axis RTCP function

Easy-to-use multi-product system solution

- Graphical guidance-assisted programming, guiding system commissioning, and visualized diagnosis
- One-network commissioning for CNC and drive, 1 ms interpolation period, and control of up to 16 interpolated and PLC axes
- One-click upgrading and backup recovery

Open user secondary development platform (protects processes developed by users)

- Compliant with PLC language standard IEC 61131-3, with ST and LD programming languages supported
- Allows the secondary development with HMI (supports mainstream programming languages and provides commissioning development tools and general-purpose TCP/IP interfaces)
- Supports the compile cycle by premium users



EtherCAT[®]
Conformance tested

CNC — MTC300 Series Generic Machine Tool CNC System

Open user secondary development platform (protects processes developed by users)

- Compliant with PLC language standard IEC 61131-3, with ST and LD programming languages supported
- Allows the secondary development with HMI (supports mainstream programming languages and provides commissioning development tools and general-purpose TCP/IP interfaces)
- Supports the compile cycle by premium users

Easy-to-use multi-product industry solution

- Supports laser functions such as laser power and follow-up adjustment controls, and cycles such as drilling and milling cycles
- One-network commissioning for CNC and drive, guiding system commissioning, and visualized diagnosis
- Developed based on Windows operating system, compatible with third-party application software, and support for one-click upgrading and backup recovery

30 years of self-developed core high-end algorithm accumulation (originates from Germany)

- Supports gantry/parallel/non-quadrature axis control and polar/cylindrical coordinate transformation
- Supports space cutter compensation, linear/circular/helical/spline interpolation, and corner smoothing/accuracy control
- Supports the curvature function, adaptive look-ahead for 4,000 segments, and five-axis RTCP function



EtherCAT
Conformance tested



Integrated AC Drive for Air Compressors

The CP650/CP700 series AC drive guarantees the efficient and stable running of air compressors, allowing the PMSM to work in the most energy-saving state. Compared with other AC drives of the same power, the CP650/CP700 has significantly enhanced overload and heat resistance capacities. With smart analysis and protection, it also prolongs the failure-free running time of air compressors and shortens the electric control cabinet installation time from 2 hours to 20 minutes.

- CP650 integrated AC drive for air compressors
- CP700 integrated AC drive for air compressors
- Air compressor IoT



Vehicle Air Conditioning Solution

With the reform of traditional automobiles, new energy vehicle air conditioning also faces upgrading. The CV800/CV100 provides air conditioning manufacturers with reliable, integrated, intelligent, and networked comprehensive vehicle air conditioning solution.

CV800 provides integrated bus air conditioning solutions.

- Small size and light weight (10 kg)
- Excellent EMC
- Reliable PTC control
- Integration of controller
- Electronic expansion valve control integrated in the controller (CA200 series)



CV800 series

CV100 provides air conditioning control drive solutions for passenger vehicles.

- Flexible customization
- High stability
- High degree of convenience



CV100 series

HVAC

The CA series AC drives meet application, system process, and industry requirements of water chilling units, light commercial units, and cold storage in the HVAC industry, including water cooling series CA300, liquid cooling series CA500, and integrated plate-type series CA200.

- With an internal C2 EMC design, the CA200-VER series AC drive is specially designed for accurate air conditioning used in equipment rooms, featuring high reliability and long service life.
- Designed for scroll and rotary compressors, the CA200 series AC drive is specially used for module machines, multi-split air conditioning, air source heat pumps, and cold storage. Its integrated film capacitor design allows for simple maintenance, long service life, and strong anti-interference capacity.
- The CA300 and CA500 are on-board AC drive cabinets for water chilling units, which provide two cooling modes: air cooling and liquid cooling.
- HD9XS is a drive specialized for high-pressure centrifugal units.



CA300/CA500 series onboard AC drive for water chilling units



CA200-VER series AC drive for accurate air conditioning



HD75S series AC drive for high-voltage centrifugal units

Wind Power Variable-Pitch Drive

The PD800 and PD802 series variable-pitch drives, which integrate drive and control, are designed based on 14 application scenarios in the wind power industry to enable safer and more reliable pitch control systems.

High safety and reliability

- DFMEA design/PFMEA manufacturing failure modes and effects analysis
- Hardware + software redundancy, protecting the fans' safety

High environmental worthiness

- C4-H corrosion protection, meeting low and high voltage ride through requirements
- Durability: passed the highly accelerated life test and highly accelerated aging test

High flexibility and openness

- Built-in CoDeSys-based PLC, meeting users' secondary development requirements
- Built-in CAN dual-drive control interface, meeting the needs of large unit applications



Integrated Drive for Water Pumps

The MD100P is an integrated drive for water pumps suitable for clear water pressure boosting and circulation of various application scenarios. It integrates the rare earth PMSM, AC drive, and PLC to realize more reliable, efficient, and energy-saving running at the end of water supply and HVAC.

High safety and reliability

- Drive IP rating: IP55
- High rated operating ambient temperature: 50°C
- Built-in filter with EMC category up to C2
- Multi-redundancy system, without sensor algorithm protection
- No quick-wear parts in the drive

Efficient and energy-saving

- Integration of IE5 rare earth PMSM
- Small capacitor, fanless design
- High drive power factor and low power loss
- Optimal efficiency cycle algorithm ensuring high efficiency of the system

Low noise

- High carrier frequency of the drive and low electromagnetic density of the motor ensure no electromagnetic noise during running.
- Fanless design of the drive, optimized overall runner design, and patented motor fan design guarantee low wind noise.



Ceramic-dedicated Motor Integrating Drive and Control

The MD100C synchronous motor integrating drive and control is developed based on the multidrive scenarios in ceramic production, such as kiln and glaze line. It automatically adjusts the voltage-frequency ratio of AC drive output according to the load ratio of the servo motor to improve the efficiency of the servo motor and drive system as well as reduce the energy consumption, noise, and vibration of the servo motor. It is suitable for flexible control in distributed applications, such as ceramic glaze line drive, logistics transportation, food machinery drive, food filling drive, and packaging drive line.

Stable running speed

- Different from the asynchronous motor, the PMSM has stable speed and good output at low frequency, without slip.
- Wide speed range
Able to run stably in the range of 3–150 Hz (corresponding motor speed: 30–1500 rpm)

Support for bus control

- Supports RS485 and CANlink communication
The master reads motor running parameters (current, voltage, running frequency, etc.) and writes motor frequency, acceleration/deceleration time, control words, and so on.

High IP rating

- IP rating: IP55
Thickened conformal coating and airtight treatment, suitable for environments with high dust and humidity
- Operating ambient temperature: 55°C

Significant energy saving

- Different from the asynchronous motor, the synchronous motor reduces the energy consumption by about 40% in multidrive applications.
- A 1.1 kW motor under continuous running can save 60 kWh of electricity every month.



MD100C synchronous motor integrating drive and control

Elevator's Electrical Accessories

Elevator's electrical accessories



HMI



Shaft electrical components

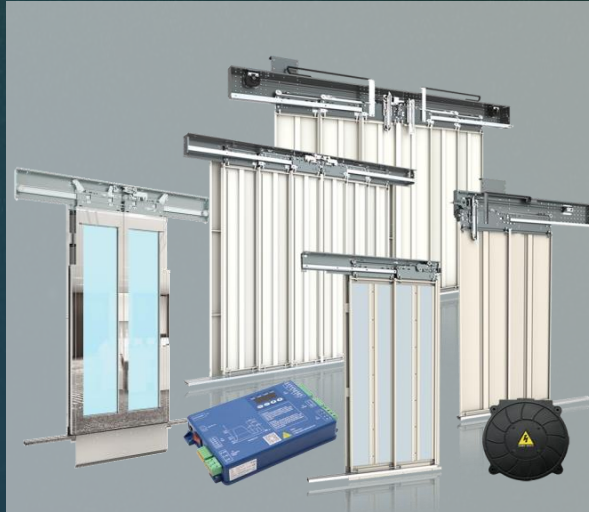

Door system



Cables

Elevator's Electrical Accessories—— HMI

Button

- A total of 382 series, over 1,000 products
- Anti-collision, fireproof, waterproof, and anti-bacterial treatments; Up to 10 million times of use
- Meets the button standards of different countries
- Healthy series products available, such as glass and touchless buttons

COP/LOP/HPI

- Applicable to a variety of environments, such as residences, hotels, shopping malls, and office buildings; Supports both backplate mounting and through hole mounting; Provides personalized solutions

Display module (TFT series)

- Covers the ELD, LCD, LED, and TFT series which adopt parallel or RS485/CAN/LAN serial transmission signal. The TFT series has won the favor of the market by virtue of colorful pages, flexibly-edited interfaces, and successful application in intelligent buildings.

Running direction indicator

- Long-life LED light source
Diversified materials meet the customization needs.



Elevator's Electrical Accessories — Shaft Electrical Components

Inovance's elevator products cover the machine room, car top, and pit, shown as follows:

1. Inspection box: multiple series available; meets standards such as EN81/GB7588 and achieves an IP rating of IP65
2. Power distribution box in machine room: exported to many countries; provides sheet metal and plastic enclosures and 16–400 A main switch, meeting the requirements of multiple elevator types
3. LED lighting: diversified styles, IP ratings, and performances available
4. Comprehensive elevator lighting system solution

Inovance also provides overall solution of shaft components except for the following products:

- Inspection box
- Power distribution box in machine room
- Shaft/Car lighting
- Intercom system



Elevator's Electrical Accessories — Door system

The BST elevator landing/car door system has the following features:

1. Covers various application scenarios and elevators with different speeds
 2. High running stability and low maintenance cost
 3. Obtained domestic and international certificates
 4. Abundant configurations
 5. Self-developed controller and motor
 6. Equipped with door vane and door lock with independent intellectual property
- Light door series
 - Standard door series
 - Heavy-load door series
 - Fireproof door series
 - High-speed elevator door series



Elevator's Electrical Accessories — Cables

Full coverage of technical standards: Both the economical traveling cables for low-speed elevators (below 4 m/s) and high-end traveling cables for high-speed elevators (12 m/s) conform to Chinese, European, Japanese and American standards, meeting the needs of different regions.

High-quality safety assurance: The flat traveling cables guarantee 3 million times of safe running.

Cutting-edge customized products: Inovance offers future-proof customized high-end solutions through flexible product design modes (Ethernet cable and fiber-optic communication included). One-stop accessory service: Inovance provides customers with diversified power cables, shaft cables, prefabricated cables, and installation accessories.

- Traveling cable
- Machine room cable
- Car cable
- Shaft cable
- Matching accessories
- Escalator processing



New Energy Products

Top-tier supplier of NEV powertrains and power supply products



Passenger vehicle



Commercial vehicle

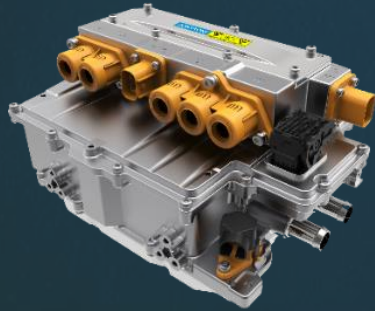

■ TM inverter



■ Traction motor



■ Power supply products

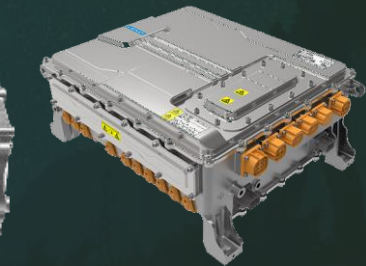
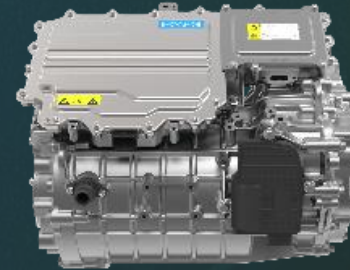

■ Powertrain

Motor, inverter, power supply products and powertrain

New Energy Products—NEV Inverter

The NEV inverters produced by INOVANCE Automotive, which features excellent performance, high safety and reliability, simple commissioning and easy installation, can meet the power requirements of various types of vehicles.

- Strong output capability, with peak current up to 500 Arms
- High EMC rating (batch production meets Class 3), and excellent anti-interference performance
- Complete protection mechanism, including junction temperature protection and low speed anti-shake
- High safety rating with high voltage interlock and active short circuit protection
- High efficiency up to 99.0%
- Wide operating temperature range, full power output at -40°C to $+105^{\circ}\text{C}$

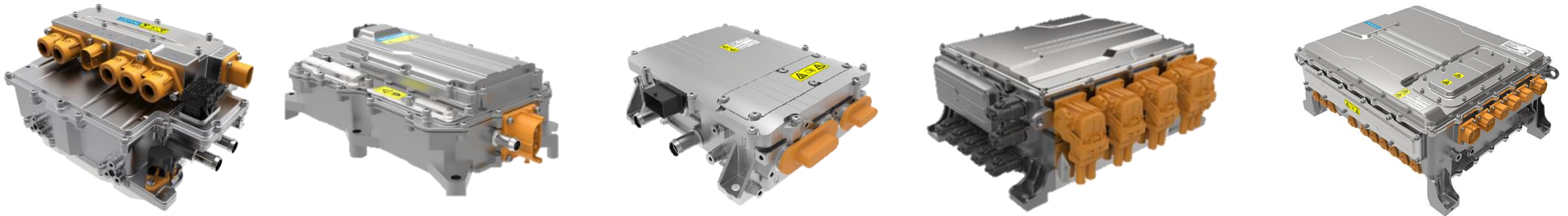

New Energy Products—NEV Motor

The NEV motor produced by INOVANCE Automotive has wide high-efficiency range and excellent NEDC and NVH performance. It features high degree of safety and reliability due to low back electromotive force and short circuit current, and high power density thanks to its light weight and compact structure. A variety of cooling methods are supported, such as water cooling and oil cooling.

- Tailored for the requirements of passenger vehicles on long range, passenger comfort and high degree of safety
- Compact: small size allows for flexible installation position and less space occupation
- Lightweight: high power density enables improved vehicle range
- Platform-based: meets the requirements of various types of vehicles



New Energy Products—NEV Power Supply Products

INOVANCE Automotive provides a wide range of new energy automotive power supply products, including DC/DC converters, OBCs and integrated power supply products. They feature small size, light weight, high power density and high efficiency and can meet the power requirements (6.6 kW, 11 kW, 22 kW) of different types of vehicles.

- All automotive-level components
- Bi-directional OBCs and DC/DCs
- Supports AUTOSAR
- Functional safety (optional): OBC ASIL B, DC/DC ASIL D

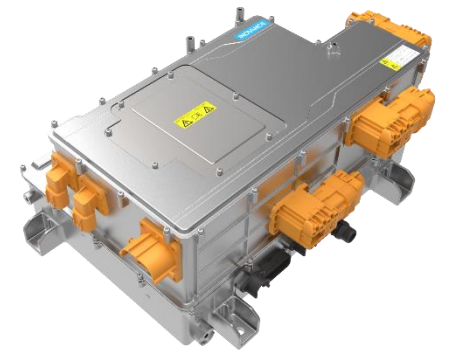

New Energy Products—NEV Powertrain

The new energy powertrain system developed by INOVANCE Automotive integrates the inverter, motor and gearbox. It has excellent anti-interference performance due to high EMC level (batch production reaches Class 3). It also comes with a variety of protection mechanism such as junction temperature protection, low-speed anti-shake, high-voltage interlock and active short circuit protection to ensure safety.

- Modular: flexible component selection and variable shapes for different vehicle requirements
- Compact: small size allows for flexible installation position and less space occupation
- Lightweight: high power density enables improved vehicle range
- Platform-based: different output torques are achieved by changing stator stack height and gearbox speed ratio to meet the requirements of various types of vehicles
- Economical: the overall vehicle cost is reduced by eliminating the three-phase cables

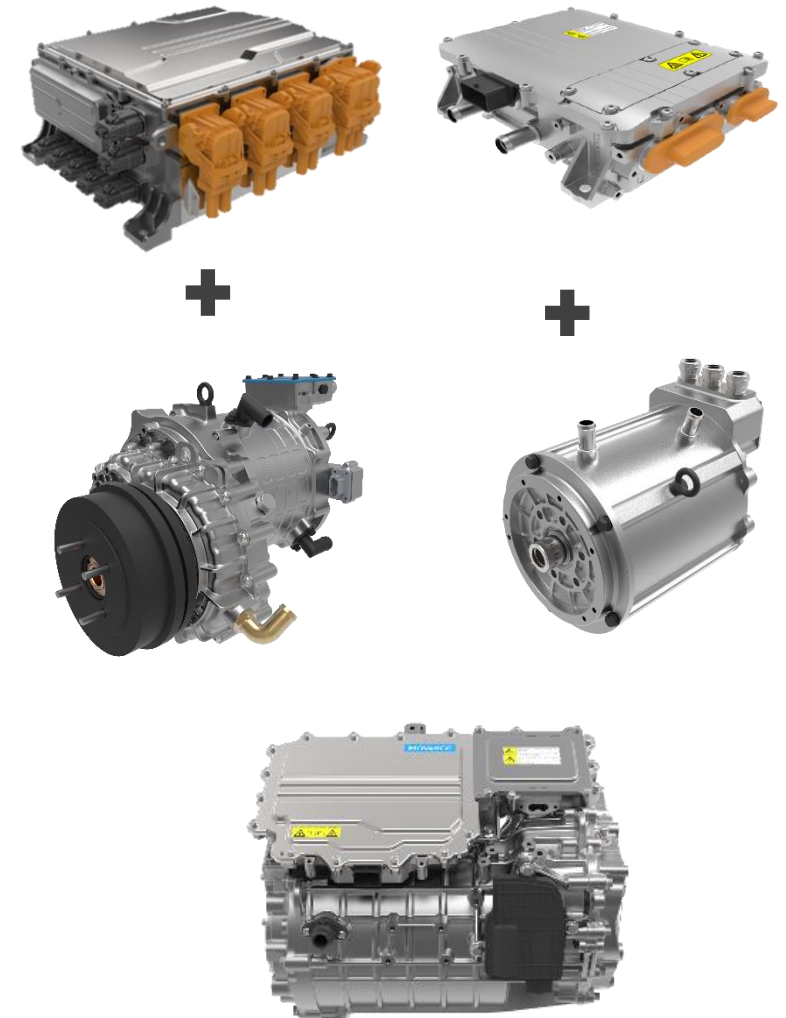

Robot Product Family

Arm length: mm

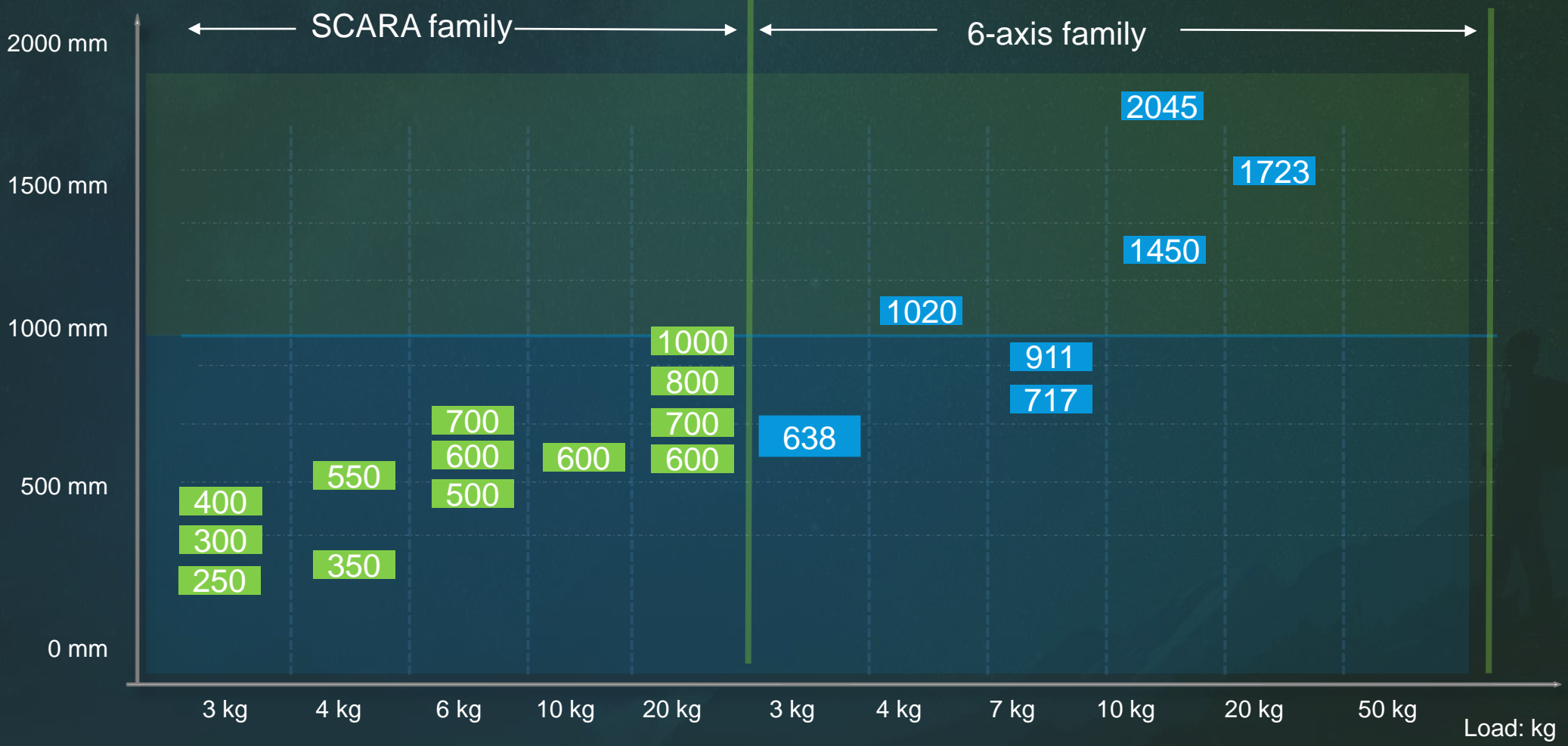

Robot -- 3 kg/6 kg/10 kg/20 kg SCARA Robot Series

Product Information

- Core robot application pioneer: planar handling and assembly with high speed and accuracy

Product Features

- Arm length: 250 mm/300 mm/400 mm/500 mm/600 mm/700 mm/800 mm/1000 mm
- Efficiency: 0.42s to 0.5s
- Repeat accuracy: ± 0.01 mm to 0.02 mm

Applicable Industries

- Planar motion applications, such as mobile phone, lithium battery, 3C, gluing, and locking

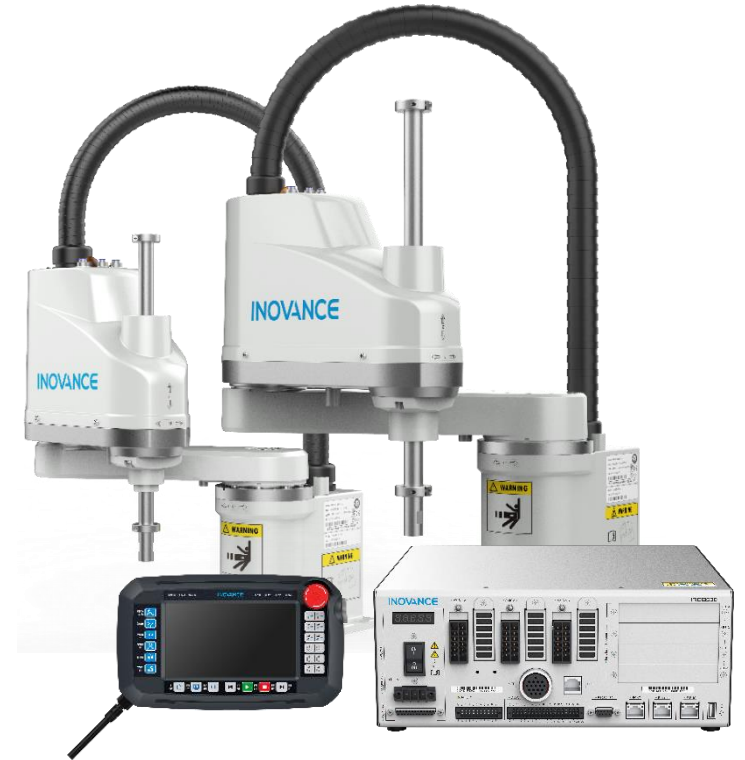

IRS111-*-***Z**TS3

Robot – 3 kg/4 kg Ceiling Mounting SCARA Robot

Product Information

- 360° rotation, ceiling mounting, excellent alternative with high speed and accuracy, meeting high requirements on installation or machining space

Product Features

- Arm length: 350 mm/550 mm
- Efficiency: 0.42s to 0.5s
- Repeat accuracy: ± 0.01 mm to 0.02 mm

Applicable Industries

- Planar motion applications requiring 360° rotation in confined space, such as mobile phone, lithium battery, 3C, gluing, and locking



IRS112-*.***Z**RS3

Robot – 3 kg/7 kg Six-axis Robot Series

Product Information

■ Featuring compact structure, lightweight, and high flexibility, repeatability, and speed, this series of robots are able to finish various operations in the workspace.

Product Features

- Arm length: 638 mm/3 kg (IP67 optional)
717 mm/911 mm/7 kg
- Efficiency: 0.42s to 0.5s
- Repeat accuracy: ± 0.01 mm to 0.02 mm

Applicable Industries

- Planar motion applications, such as mobile phone, lithium battery, 3C, gluing, locking, assembly, and grinding

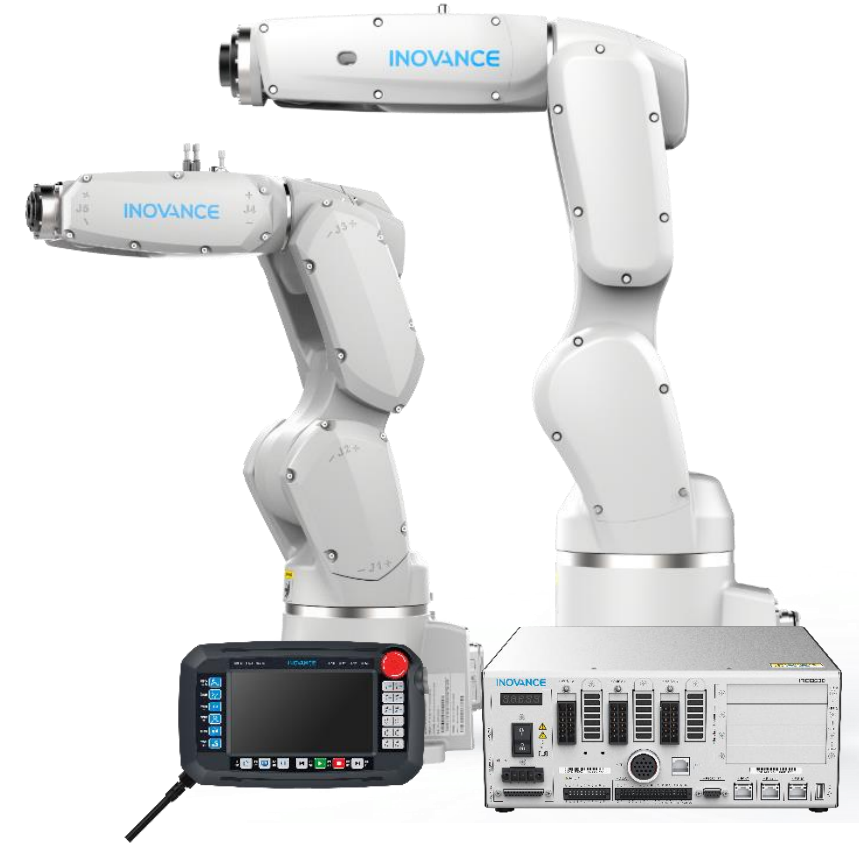

IRS311-*-*TS5

Robot – 10 kg/20 kg Six-axis Robot Series

Product Information

- 6-axis robot for heavy-load operations with industry-leading control technology and vibration suppression functions and wrist joint with IP67 rating for working in harsh environments with oil mist and splashing water

Product Features

- Arm length: 1723 mm/20 kg
2045 mm/10 kg
1428 mm/10 kg
- Efficiency: 0.42s to 0.5s
- Repeat accuracy: ± 0.05 mm

Applicable Industries

- Complex applications including loading and unloading and trajectory in the fields such as 3C, glass, metallurgy, metal products, cables, and household appliances



IRS300-*-*TS5

Robot – Customized Robot

Product Information

- The robots customized for the fitting process and applications can effectively reduce the costs and achieve greater economic benefits while the on-site production quality is improved.

IRS10 series 3-axis robot



Load: 6 kg
Arm length: 560 mm
Motion axis: R axis/R axis/Z axis
Suitable for locking and gluing applications in 3C and home appliance industries

IRS11 series 3-axis robot



Load: 6 kg
Arm length: 560 mm
IP rating: IP67
Motion axis: R axis/R axis/R axis
Suitable for loading and unloading process applications in the machine tool industry

IRS12 series 5-axis robot



The specially designed fifth axis can be seamlessly integrated with the standard SCARA robot, featuring simple operation. The angle of fifth axis can be adjusted continuously to meet requirements on multi-angle process adjustment.

Introduction to the Robot Control Cabinet

IRCB500 series integrated drive control cabinet

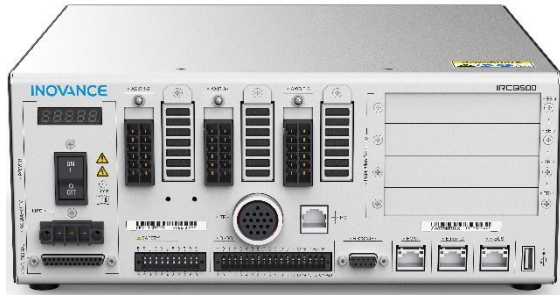

Specially designed for small industrial robots, the control cabinet features light structure, rich functions, and easy installation and expansion, meeting the manufacturing requirements of 3C industry on more compact equipment, higher production capacity, and more flexible operation.

Used with the 10 kg and 20 kg six-axis robots, the control cabinet provides strong safety protection, rich functions, and safe and easy-to-use operations.

IRCB100 series vertical control cabinet



Applicable Robots

Robot		IRCB500	IRCB100
SCARA	IRS111 series	●	×
	IRS112 series	●	×
6-axis robot	IRS311-3/7 series	●	×
	IRS301-10 series	×	●
	IRS300-20 series	×	●
Others	IRS10 series	●	×
	IRS11 series	●	×
	IRS12 series	●	×

Interaction Capabilities of Robot Systems

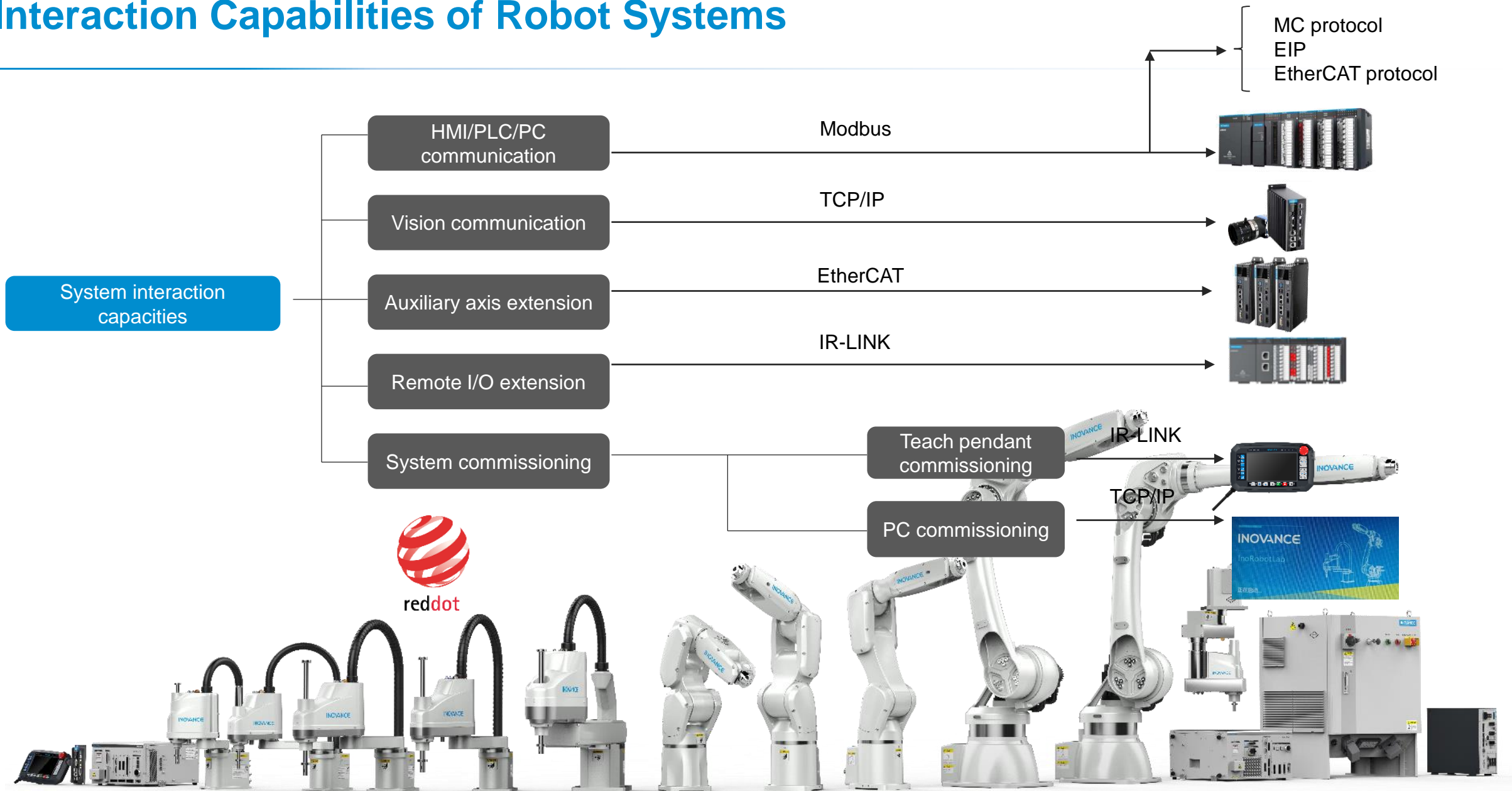

Robot Application Platform -- Powerful Programming Tools

Teach pendant

Teach pendant series:

Teach pendant software (PC version): InoTeachPad

Hand-held teach pendant: ITP80

- Menu-type instruction editing mode, quick and easy to get started
- Wizard-based process module design, easy to use in complex processes
- Keywords colored on the neat and clear programming page, convenient for reading
- API function calls, no need to learn robot language



PC-based software: InoRobotLab

- Highly efficient expert programming environment with functions such as intelligent input, grammar prompt, automatic error checking, and program folding
- Convenient commissioning with breakpoint commissioning, multi-task commissioning, and combination of different monitoring parameters
- Brand-new Ribbon UI

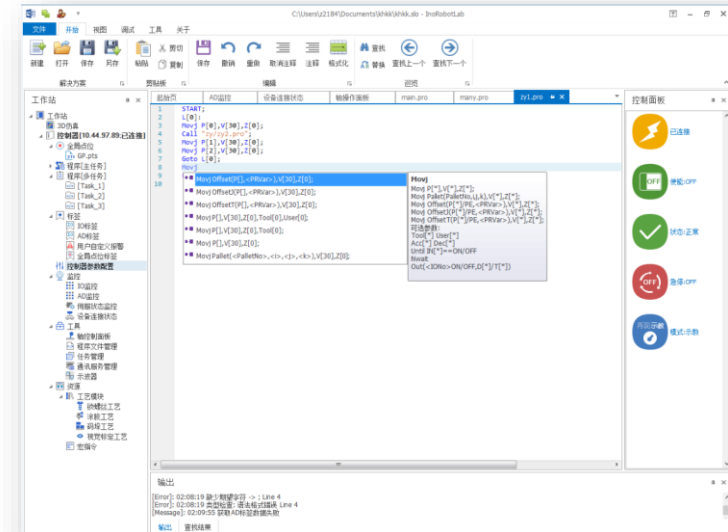

Robot Application Platforms

InoRobotLab Programming and Commissioning Software -- Simple Interface, Flexible Programming, and Visualized Commissioning

PC-based programming mode

- Automatic grammar prompt
- Automatic grammar completion
- Folding and unfolding of program logic



```
double sddk1 = StrTod("0x080B275");
Movc.
  ■ Movc P[<i>],V[30],Z[0],Tool[0];
  ■ Movc P[<i>],V[30],Z[0],Tool[0],User[0];
  ■ Movc Pallet[<PalletNo>,<i>,<j>,<k>],V[30],Z[0];
  ■ Movc Offset[P[<i>],PR[<j>]],V[30],Z[0];
  ■ Movc Offset3[P[<i>],PR[<j>]],V[30],Z[0];
  ■ Movc OffsetT[P[<i>],PR[<j>]],V[30],Z[0];
```

Easy commissioning

- Breakpoint commissioning and single-step commissioning
- Multi-task simultaneous commissioning
- Integrated servo monitoring, commissioning, and programming functions

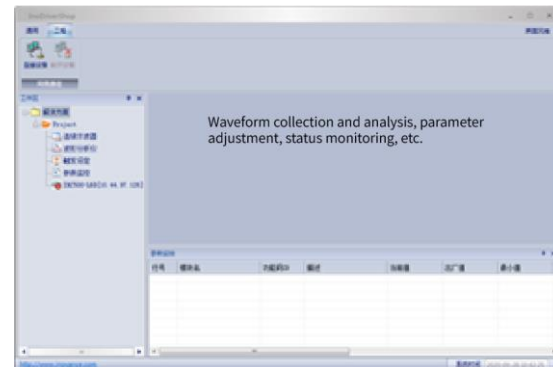

Flexible variables

- Customized labels
- Customized variables and variable attributes
- Structure and array definitions

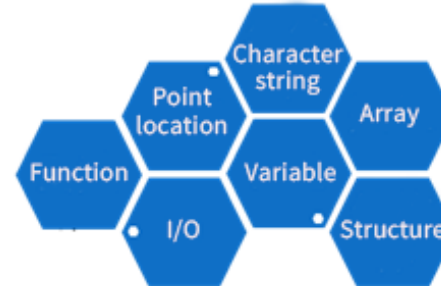

Integrated monitoring window

- Combined monitoring of I/O, point locations, values, and character string variables on the same interface
- Alarm information displayed with possible causes and solutions, no need for further reading user guides

D[3]	未定义	变量(Variable)	→ I/O state
R[4]	未定义	变量(Variable)	→ Value variable
IG[0]	未定义	变量(Variable)	
OG[1]	未定义	变量(Variable)	
P_Pick	未定义	结构体(Struct)	
Data[0:2]	未定义	数组(Array)	
ArmType[0:3]	未定义	数组(Array)	
CrdNo	未定义	变量(Variable)	→ Character string variable
ToolNo	未定义	变量(Variable)	
UserNo	未定义	变量(Variable)	
B[0:4]	未定义	数组(Array)	
[0]	未定义	变量(Variable)	→ Position variable
[1]	未定义	变量(Variable)	
[2]	未定义	变量(Variable)	
[3]	未定义	变量(Variable)	
[4]	未定义	变量(Variable)	

Rail Transit



Jiangsu Kingway Transportation Co., Ltd. is the only private enterprise in China that has independent core technologies and R&D capability based on the European technology platform. It can independently bid for a whole set of traction control system. It can produce up to 800 sets of converters and medium-voltage boxes and 3200 medium-power traction motors each year, meeting delivery requirements of the traction and control equipment of over 200 trains.

- | | |
|-----------------------------|---------------------------------|
| ■ Metro auxiliary converter | ■ Rail tram auxiliary converter |
| ■ Metro medium-voltage box | ■ Rail tram medium-voltage box |
| ■ Metro traction converter | ■ Rail tram traction converter |
| ■ Metro traction motor | ■ Rail tram traction motor |

